



EN 54-2
EN 54-4



0051
0051-CPR-0225
0051-CPR-0226
0051-CPR-0227
0051-CPR-0228
0051-CPR-0231
0051-CPR-0232



SmartLoop
Analogue fire alarm control panel
Installation manual



GameOver

Copyright

The information contained in this document is the sole property of INIM Electronics s.r.l. No part may be copied without written authorization from INIM Electronics s.r.l.

All rights reserved.

European directive compliance

This control panel has been designed and developed to the highest standards of quality and performance implemented by INIM Electronics s.r.l.

This control panel must be installed in accordance with the instructions described in this manual and in compliance with the laws in force.

All control panels from the SmartLoop series are **EN54-2** and **EN54-4** compliant.

All control panels from the SmartLoop series, and all accessory items and special functions have IMQ-Security systems certification, unless otherwise stated.

Declarations of performance, declarations of compliance and certificates relating to the products mentioned in this manual can be downloaded from the following website:

www.inim.biz/certifications

Table of contents

	Copyright	2
	European directive compliance	2
	Table of contents.....	3
Chapter 1	Overview.....	5
1.1	Application and use	5
1.2	Other parts of the system	7
1.3	To warrant the IMQ-SISTEMI DI SICUREZZA certification and to comply with EN 54-2	8
1.4	About the SmartLoop fire alarm panel series	8
1.5	Description of the models	8
1.6	Features	9
Chapter 2	General information	10
2.1	Supplied documentation	10
2.2	Manual details	10
2.3	Operator classification - Access Levels	10
2.4	Intellectual property rights	10
2.5	Disclaimer	10
2.6	Recommendations	11
2.7	System Test	11
2.8	Note to the installer	11
2.9	Technical support	11
2.10	Conventions	11
2.11	CE Mark	12
2.12	Warranty	13
2.13	Safety laws	13
Chapter 3	Device management	15
3.1	Transport of goods	15
3.2	Environmental conditions	15
3.3	Unpacking the device	15
Chapter 4	Technical description.....	16
4.1	Control panel	16
4.2	The motherboard	16
4.3	LED Panel	18
4.4	Switching power supply	19
4.5	Technical specifications	19
Chapter 5	Accessory devices.....	21
5.1	Attachment boards	21
5.2	SmartLoop/PRN Printer	25
5.3	The SmartLetUSee/LCD and SmartLetUSee/LED Repeater panels	26
Chapter 6	Installation	27
6.1	Choosing the mounting location	27
6.2	Installation flow, guidelines and testing	27
6.3	Connecting the SmartLoop/PRN printer module	28
Chapter 7	Connections.....	29
7.1	Note to the Installer regarding wiring and connection compliancy	29
7.2	About the circuitry	29
7.3	Loop Connections	29
7.4	NAC outputs (Notification Application Circuit)	32
7.5	PL Terminal	32
7.6	AUX output	33
7.7	AUX-R output	33

7.8	Relay output	33
7.9	Connecting devices to the RS485 BUS	33
7.10	Connecting the SmartLoop/NET module	35
7.11	Connecting the SmartLoop/INOUT Board	35
7.12	Connecting to a PC	36
7.13	Connecting a SmartLAN (or SmartLAN/SF) equipped control panel to a PC	37
7.14	Connecting a serial printer	37
7.15	Batteries	37
7.16	Connecting the thermal probe	38
7.17	Connecting the mains power source	38
Chapter 8	Powering up the system	40
8.1	Testing wiring integrity	40
8.2	First power up	40
Chapter 9	Maintenance	42
Chapter 10	Troubleshooting	43
10.1	Fault NAC, alarm or fault output trouble	43
10.2	LOOP fault	43
10.3	Fault on devices connected to the RS485 BUS	44
10.4	Battery Fault	44
10.5	SmartLoopNET Fault	44
10.6	Other faults	45
Appendix A	Enea series devices	46
Appendix B	Argus Devices	49
Appendix C	Apollo devices	53
Appendix D	Order codes	57
	Notes	59

Overview

Note: *The control panels described in this manual have been designed and manufactured to the highest standards of quality, reliability and performance adopted by INIM Electronics. The components selected for this product will operate properly within their specifications when the environmental conditions outside the product enclosure comply with Class 3k5 (EN 60721-3-3).*

Danger: **The GAS control function is not provided for in the aforesaid standard and therefore cannot be considered EN54-2 compliant.**

Danger: **In order to validate the IMQ-SISTEMI DI SICUREZZA certification, and in compliance with the EN54-2 standard, all the manual alarm buttons and fire detectors employed in the system must be associated with fire detection and alarm functions.**

1.1 Application and use

The SmartLoop analogue-addressable fire alarm panel manages up to eight loops. The SmartLoop is capable of working in a network environment (maximum configuration 30 nodes arranged in a token ring). The loops accommodate different types of fire-security devices (detectors, input and output modules, call points, fire bells, etc.). The maximum loop wire length is 2000 m. The SmartLoop also provides supervised outputs which provide full control of peripheral device functions (e.g. fire bells). The panel identifies and signals alarm, pre-alarm, fault, early warning, bypassed zone, test and monitoring conditions. The system status is indicated on the display and on the system status LEDs. The SmartLoop panel supports up to 14 Repeater panels (accessory items) which replicate system signals/data and allow building occupants with Level 2 authorization to silence and reset the system. The panel can also be connected to a PC or printer.

The automatic addressing and programming features allow rapid commissioning of the system.

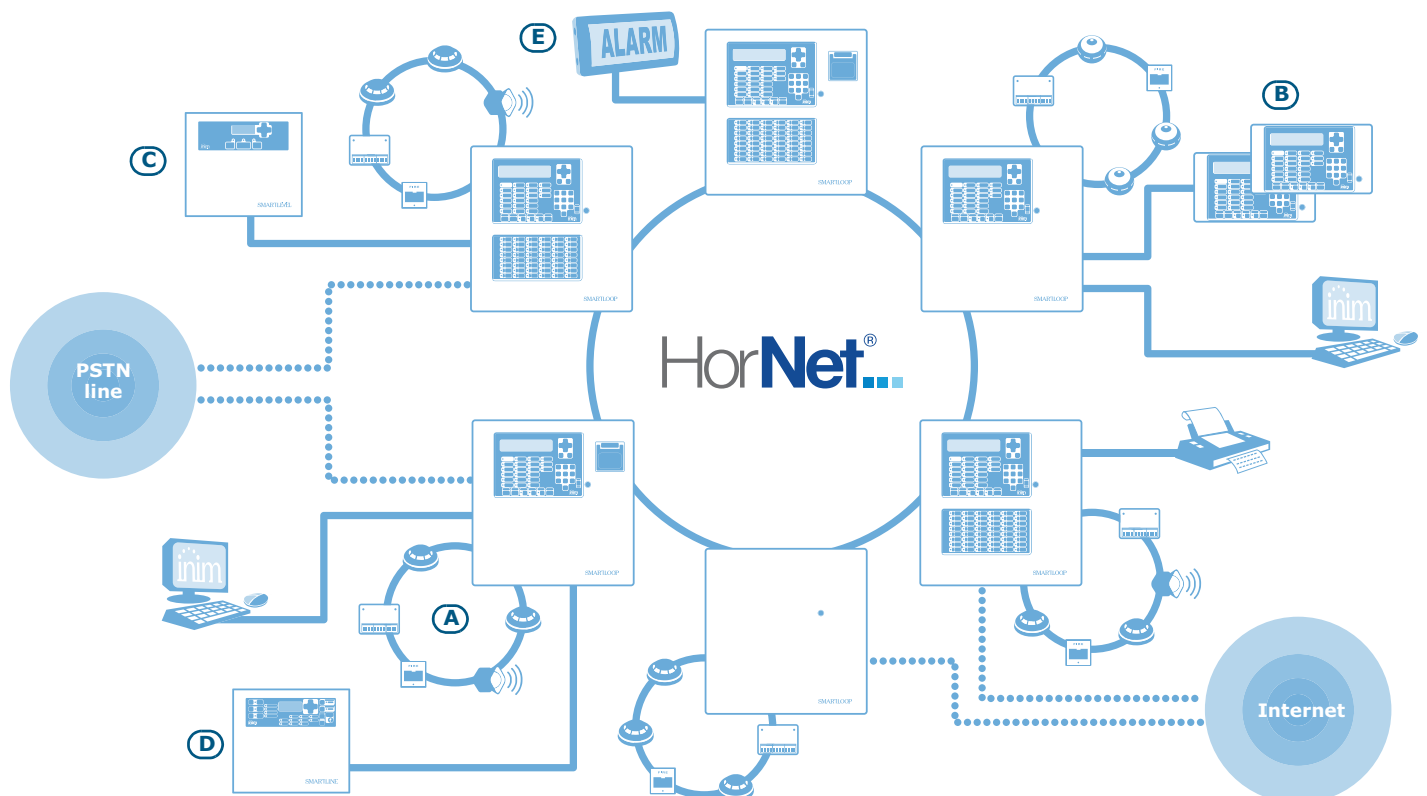

Figure 1 - Example configuration: 6 node token-ring network layout (HorNet)

[A] Loop

All the peripheral devices of the system must be connected in parallel to the loop circuit (2 pole shielded cable). The circuit is considered a "loop" because the wiring path starts at the loop-out terminals, passes through all the protected areas, connects all the system devices in parallel and returns to the loop-in terminals. The panel controls and communicates with the loop devices via digital protocol. The loop utilizes the same two poles for the power supply to the system devices and the two-way communication channel. The loop accommodates:

1. **Detectors:** active fire sensing devices that detect smoke and/or flames and, when necessary, trigger alarms thereby alerting building occupants. Detectors can be:
 - Optical smoke detectors: capable of sensing for the presence of smoke. These devices use the light scattering principle which allows detection of smoke particles in the sensing chamber (Tyndall effect).
 - Optical/Heat detectors: as per optical smoke detectors, but also capable of sensing for increase in temperature. The combination of both sensing methods (smoke and heat) provides faster detection and reduces the false alarm rate.
 - Heat detectors: capable of sensing for an increase in temperature in the protected environment. These can be either fixed temperature detectors (which generate an alarm signal when the ambient temperature exceeds the pre-set temperature threshold) or rate-of-rise (which respond to a rapid rise in temperature).
 - Ionization smoke detectors: capable of sensing for a change in electrical conductivity across the detection chamber. These devices feature a harmless radioactive source within a dual detection chamber.
 - CO detectors: capable of sensing for the presence of carbon monoxide (an odourless compound produced by incomplete combustion). This type of detector is often combined with a temperature detector.
2. **Input Module:** a device which monitors the status of another device (manual call-point, detector, etc.) and sends the respective information to the panel. This device adapts all types of apparatus to the loop.
3. **Output module:** a device which provides the control panel with a controlled output. The activation trigger of this output can be defined during the system configuration phase. This device interfaces all types of loop devices (fire bells, signaling devices, fire door magnets, etc.).
4. **Manual call point:** a device (alarm button) showing instructions for the manual activation of a fire alarm. This device is usually located in strategic positions especially near building entry/exit points. When activated these devices trigger system alarms.
5. **Sounder/Flasher:** an audible/visual alarm signaling device.

For the list of the devices the loop accommodates, and for details regarding their wiring and operating principles, refer to *Appendix A - Enea series devices*, *Appendix B - Argus Devices* and *Appendix C - Apollo devices*.

The loop circuit configuration (as required by the local Fire code in force) is a fault-tolerant circuit which, in the event of short-circuit or loop interruption, allows the panel to continue to communicate and drive the elements on either side of the interruption.

Isolator

In order to provide a fault-tolerant loop circuit that is Fire code compliant, isolator must be wired in series to the loop circuit. These devices detect short-circuits and in response interrupt the loop circuit. In the event of a short-circuit, the isolators at either side of the shorted segment will isolate it from the rest of the loop thus allowing all other segments to operate normally. No more than 32 detectors/devices can be installed between two isolator modules.

Note: *Many devices already have built-in isolators and therefore do not require isolator modules. Refer to Appendix A, Appendix B and Appendix C for further details.*

[B] Repeater SmartLetUSee/LCD (accessory item)

This optional system enhancement tool (equipped with keypad, LEDs, fast buttons and display) replicates all the system data. The control panel manages up to 14 repeaters which can be connected at a distance of up to 1000m from the control panel via RS485 BUS. These devices are usually located near building entry/exit points in order to allow personnel to obtain information regarding zones affected by alarm conditions without actually entering the premises.

[C] SmartLevel power supply station (accessory item)

The SmartLevel is the ideal power source for all devices located in the area protected by the fire detection system. Its internal board meets all EN54 requirements and provides complete supervision of the power station. This device can be connected to the control panel loop via an input/output module (not included), installed inside the box, or by means of the RS485 BUS, thus allowing the complete supervision of the power station and control of the 3 outputs.

[D] SmartLine-EXT extinguishing panel (accessory item)

SmartLine-EXT fire-extinction panels are based on SmartLine conventional fire detection panels (4-zones). These control panels provide all the functions of SmartLine conventional fire-detection panels plus 1 SmartLetLoose/ONE extinction channel.

They interface with SmartLoop control panels via a built-in RS485 BUS. It is possible to program the SmartLine-EXT fire-extinction control panel to activate its functions in response to "local" data/signals (conventional zones, fire-extinction terminals, stop extinction terminals, etc.), or in response to "remote" data/signals coming from the SmartLoop control panel.

[E] Sounderflashers

These audible/visual alarm signalling devices connect to the control panel outputs and are capable of signalling specific conditions. The activation trigger (alarm, pre-alarm, warning, etc.), can be specified during the system configuration session.

1.2 Other parts of the system

Point: synonym and definition of a loop device (detector, etc.).

Zone: a group of points (detectors, etc.). The points can be assigned to the zones during the configuration phase. Consult your local Fire code for the rules regulating automatic fire detection installations and for full details regarding zone limitations.

Switching power supply: this unit, starting from the mains power supply (230V~) it connects to, supplies the board with a 24V (27,6V---) stabilized current capable of feeding the control panel and recharging the batteries. The EN54-4 compliant power-supply module is housed below the motherboard. The mains power supply (230V~) the primary power source of the system. Refer to *paragraph 4.4 Switching power supply*.

Batteries: the secondary power source of the system. The panel houses two lead batteries @ 12V 17Ah (connected in series). The system monitors the battery status (efficiency and charge). In the event of inefficient or low battery conditions, the system will signal battery fault. In the event of primary power failure (230V~), the batteries will take over automatically. If the problem persists for a long period thus causing the battery charge to drop below the minimum value required, they will be shutdown automatically in order to avoid damage. Refer to *paragraph 7.15 Batteries*.

Thermal probe: an accessory tool, to be connected to the panel and attached to the battery pack. This device monitors the temperature of the external battery pack and regulates the battery charge accordingly. Refer to *paragraph 7.16 Connecting the thermal probe*.

RS485 Bus: 4 wire BUS for the Repeater connections. Cabling must be done with 4 pole braided shielded cable. Refer to *paragraph 7.9 Connecting devices to the RS485 BUS*.

Timer: a logical entity (the panel provides 8 timers) for automatic time-management of preset intervals (2 intervals per day) on preset days of the week and specific dates. The timers can be used in equations and/or to manage predefined operations.

Equation: a group of logical conditions defined by the installer. An equation comprises a series of operators (AND, OR, +, etc.) and a series of operands (Points, Zones, Timers, etc.). An equation can be associated with an output that will activate when the equation is satisfied.

Holidays: a list of days defined during the system configuration session which are associated with the control panel timers.

Early Warning: a signal generated by detectors with the early-warning feature (to be defined during the system configuration phase). The detector senses for a level of smoke or heat that exceeds its early warning threshold (each detectors can be set separately). This signal indicates that the person/s responsible for the safety of the building and its occupants should verify the alarm or check the functionality of the detector concerned.

1.3 To warrant the IMQ-SISTEMI DI SICUREZZA certification and to comply with EN 54-2

- All the manual alarm buttons and fire detectors employed in the system must be associated with fire detection and alarm functions.
- The functions associated with the programmable LEDs on the control panel frontplate (keypad/display and LED board), on SmartLetUSee/LCD repeaters and SmartLetUSee/LED boards must be set in accordance with the colour of the LEDs:
 - Red: fire alarm
 - Yellow: fault, test and disabled status

Note: *The GAS control function is not EN54-2 compliant, as this feature is not mentioned in the aforesaid standard.*

1.4 About the SmartLoop fire alarm panel series

There are 3 *expandable* models (expandable to 8 loops by means of 3 SmartLoop/2L expansion boards). Each expandable model provides 2 loops, the dimensions of the enclosures of all three models are identical. Each expandable model has a technically-downsized version (in same-sized enclosure) with 1 loop for reduced complexity applications.

All models manage the same functions and support a full spectrum of hardwired and wireless devices.

The SmartLoop fire alarm panel series provides the following models:

- **SmartLoop1010/P** - fully-equipped frontplate model with 1 loop
- **SmartLoop2080/P** - fully-equipped frontplate model with 2 loops expandable to 8
- **SmartLoop1010/G** - keypad and display model with 1 Loop
- **SmartLoop2080/G** - keypad and display model with 2 loops expandable to 8
- **SmartLoop1010/S** - flush front model with 1 loop
- **SmartLoop2080/S** - flush front model with 2 loops expandable to 8



SmartLoop1010/P
SmartLoop2080/P



SmartLoop1010/G
SmartLoop2080/G



SmartLoop1010/S
SmartLoop2080/S

Figure 2 - SmartLoop Series

1.5 Description of the models

The "/P" model frontplate is equipped with a keypad, display, signalling, function buttons and zone status LEDs and is suitable for installation in locations where visual signals and manual control are necessary. This model can be enhanced with the SmartLoop/PRN thermal printer (optional accessory item).

The "/G" model frontplate is equipped with a keypad, display, signalling LEDs and function buttons and is suitable for installation in locations where visual signals and manual control are necessary. In the same way as the "/S" model, the "/G" model can be upgraded at any time by replacing its frontplate.

The "/S" model has an unequipped frontplate and therefore does not provided a user interface (display, LEDs or buttons) and is suitable for installation in locations where visual indications and manual control are not required, for example basements. This model can be upgraded at any time after installation (for example, if moved to a location where visual signals and manual control are necessary) by replacing its door with a "/G" model or "/P" model door.

1.6 Features

- Manages up to 240 zones per panel with network-zone architecture feature
- Network environment capable (maximum configuration 30 panels)
- Group and Zone sharing among panels in the network environment
- Switching power supply @ 160W, 27.6V---with battery charger function
- 2 on-board loops on expandable 2080 models; 1 on-board loop on non-expandable 1010 models
- 3 programmable NAC outputs
- 1 Alarm NAC output
- 1 Fault NAC output
- 1 alarm signalling relay (voltage free)
- 1 fault signalling relay (voltage free)
- RS485 BUS for the connection of up to 14 SmartLetUSee/LCD repeaters, 4 SmartLevel power stations and 4 SmartLineEXT fire-extinction stations
- 1 output @24V for the power supply to devices external to the system.
- 1 resettable output @24V for the power supply to peripheral devices that unpower during reset operations.
- RS232 and USB connectors for uploading/downloading programming data
- 2000 event buffer

The motherboard provides housing for:

- 3 SmartLoop/2L loop expansion boards with 2 loops per board (2080 expandable models only)
- 1 SmartLoop/NET network board
- 1 SmartLAN or SmartLAN/SF board
- 1 SmartLoop/PSTN board
- 1 SmartLoop/INOUT Input/Output expansion board
- 1 SmartLoop/LED zone-status LED module (for "/P" models only)
- 1 SmartLoop/PRN thermal printer module (for "/P" models only)

Note: *The 1010 non-expandable models with 1-loop have exactly the same features and components as the 2080 expandable models with 2-loops.*

Chapter 2

General information

2.1 Supplied documentation

- Installation Manual (this manual)
- Programming Manual
- User's Manual

These manuals are supplied with the apparatus. For further copies of the Installation Manual, please contact INIM ELECTRONICS offices quoting the order number shown in *Appendix D - Order codes*.

2.2 Manual details

- Title: SmartLoop Installation Manual
- Version: 3.50
- Code: DCMIINE0SLOOP
- Recipient: installer, service technicians

2.3 Operator classification - Access Levels

Level 1

All building occupants can view the system status (active events) and events log and silence the panel beeper.

Level 2

ONLY authorized keyswitch users and PIN users (5 digit codes) can Enable/Disable loop devices, bell outputs, software zones and network devices, and SILENCE or RESET the system.

Level 3

ONLY authorized technicians should, by means of a screwdriver, remove the screws and open the control panel enclosure in order to insert the programming jumper J2; and, after doing so, using a valid 5-digit PIN access the parameter programming phase and/or carry out maintenance work (e.g. change the battery, replace fuses, etc.).

Level 4

ONLY authorized technicians, appointed by the Manufacturer can, by means of special tools, carry out repair work on the motherboard (for example, repair or replace SM components).

Note: *The access code is "00004" at default.*

2.4 Intellectual property rights

The information contained in this document is private property. All rights reserved.

This document must not be reproduced, either totally or in part, without the prior written consent of INIM Electronics, and refers to the devices specified in *paragraph 4.1 Control panel*.

2.5 Disclaimer

INIM Electronics s.r.l. shall not be responsible for damage arising from improper application or use.

This control panel should be handled by qualified personnel only. Installation must be carried out strictly in accordance with the instructions described in this manual, and in compliance with the local fire code in force.

2.6 Recommendations

INIM Electronics recommends that the entire system be checked completely at regular intervals (refer to *paragraph 2.7 System Test*).

2.7 System Test

This system has been designed to provide the highest standards of reliability and performance. Malfunction of any of the system devices may cause the system to be incapable of reaching the intended levels of performance. Most problems which prevent the system from operating as intended can be found by regular testing and maintenance of the system devices (refer to *Chapter 9 - Maintenance*).

The test must include all the system detectors, signalling devices and all other devices that are part of the system.

2.8 Note to the installer

In order to provide adequate protection and instructions for correct use of the apparatus, you (the installer) must be fully aware of the regulations and operating procedures of firefighting. As the only individual in contact with system users, it is your responsibility to instruct them on how to use this system properly and to bring to their attention that every fire is different in the amount of smoke and rate of burning. Therefore, smoke and heat detectors may not provide timely warning of fires caused by violent explosions, escaping gas or improper storage of inflammable materials.

Regardless of its capabilities, a fire alarm system is not a substitute for the necessary precautions building occupants must take to prevent or minimize the harmful effects of fire.

2.9 Technical support

Our professional engineers are readily available to assist you. If you require help, call us and you will be put through to a person capable of answering your questions and providing you with the service you need.

2.10 Conventions

2.10.1 Terminology

Panel; device; system: refer to the devices defined in *paragraph 4.1 Control panel*.

Left, right, in front of, behind, above, below: refer to the directions as seen by the operator in front of the mounted device.

Communicator (telephone, SMS, digital): synonym of dialer.

STP: synonym of shielded twisted pair cables

Qualified personnel: those persons whose training, expertise and knowledge of the laws and bylaws regarding service conditions and the prevention of accidents, are able to identify and avoid all possible situations of danger.

Select: click on and select a specific item (from drop-down menu, options box, graphic object, etc.).

Press: click on a video button, or press a key on the panel keypad.

2.10.2 Graphic conventions

Following are the graphic conventions used in the text.

Conventions	Example	description
<i>Text in Italics</i>	Refer to <i>paragraph 2.10.2 Graphic conventions</i>	Text in italics: indicates the title of a chapter, section, paragraph, table or figure in this manual or other published reference.
<text>	#<CustomerCode>	Variable data.
[uppercase letter] or [number]	[A] or [1]	Identifies a system component or video object.
BUTTON	CANC, ESC, RESET	Computer or control panel keys.

Note: The detached notes contain important information about the text.

Attention: The attention prompts indicate that total or partial disregard of the procedure could damage the connected devices.

Danger: The danger warnings indicate that total or partial disregard of the procedure could injure the operator or persons in the vicinity.

2.11 CE Mark



 0051	 0051	 0051																																																																																																									
INIM ELECTRONICS S.R.L. Via Fosso Antico snc - Fraz. Centobuchi 63076 Montepandone (AP) - Italy 09 0051-CPR-0228	INIM ELECTRONICS S.R.L. Via Fosso Antico snc - Fraz. Centobuchi 63076 Montepandone (AP) - Italy 09 0051-CPR-0231	INIM ELECTRONICS S.R.L. Via Fosso Antico snc - Fraz. Centobuchi 63076 Montepandone (AP) - Italy 09 0051-CPR-0232																																																																																																									
EN 54-2:1997 + A1:2006 EN 54-4:1997 + A1:2002 + A2:2006 SmartLoop1010/S Control and indicating equipment with integrated power supply equipment for fire detection and fire alarm systems installed in buildings	EN 54-2:1997 + A1:2006 EN 54-4:1997 + A1:2002 + A2:2006 SmartLoop1010/G Control and indicating equipment with integrated power supply equipment for fire detection and fire alarm systems installed in buildings	EN 54-2:1997 + A1:2006 EN 54-4:1997 + A1:2002 + A2:2006 SmartLoop1010/P Control and indicating equipment with integrated power supply equipment for fire detection and fire alarm systems installed in buildings																																																																																																									
<table border="1"> <thead> <tr> <th>Essential characteristics</th> <th>Performance</th> </tr> </thead> <tbody> <tr><td>Performance under fire conditions</td><td>PASS</td></tr> <tr><td>Performance of power supply</td><td>PASS</td></tr> <tr><td>Response delay (response time to fire)</td><td>PASS</td></tr> <tr><td>Operational reliability</td><td>PASS</td></tr> <tr> <td rowspan="4">Durability of operational reliability:</td> <td>temperature resistance</td> <td>PASS</td> </tr> <tr> <td>vibration resistance</td> <td>PASS</td> </tr> <tr> <td>electrical stability</td> <td>PASS</td> </tr> <tr> <td>humidity resistance</td> <td>PASS</td> </tr> <tr> <th>Options provided according to EN 54-2</th> <th>Performance</th> </tr> <tr><td>7.8 Output to the fire alarm device</td><td>PASS</td></tr> <tr><td>7.11 Delays to outputs</td><td>PASS</td></tr> <tr><td>7.12 Dependencies on more than one signal (Type B and C)</td><td>PASS</td></tr> <tr><td>8.3 Fault signals from points</td><td>PASS</td></tr> <tr><td>8.9 Output to warning routing equipment</td><td>PASS</td></tr> <tr><td>9.5 Disabling of addressable points</td><td>PASS</td></tr> <tr><td>10 Test condition</td><td>PASS</td></tr> </tbody> </table>	Essential characteristics	Performance	Performance under fire conditions	PASS	Performance of power supply	PASS	Response delay (response time to fire)	PASS	Operational reliability	PASS	Durability of operational reliability:	temperature resistance	PASS	vibration resistance	PASS	electrical stability	PASS	humidity resistance	PASS	Options provided according to EN 54-2	Performance	7.8 Output to the fire alarm device	PASS	7.11 Delays to outputs	PASS	7.12 Dependencies on more than one signal (Type B and C)	PASS	8.3 Fault signals from points	PASS	8.9 Output to warning routing equipment	PASS	9.5 Disabling of addressable points	PASS	10 Test condition	PASS	<table border="1"> <thead> <tr> <th>Essential characteristics</th> <th>Performance</th> </tr> </thead> <tbody> <tr><td>Performance under fire conditions</td><td>PASS</td></tr> <tr><td>Performance of power supply</td><td>PASS</td></tr> <tr><td>Response delay (response time to fire)</td><td>PASS</td></tr> <tr><td>Operational reliability</td><td>PASS</td></tr> <tr> <td rowspan="4">Durability of operational reliability:</td> <td>temperature resistance</td> <td>PASS</td> </tr> <tr> <td>vibration resistance</td> <td>PASS</td> </tr> <tr> <td>electrical stability</td> <td>PASS</td> </tr> <tr> <td>humidity resistance</td> <td>PASS</td> </tr> <tr> <th>Options provided according to EN 54-2</th> <th>Performance</th> </tr> <tr><td>7.8 Output to the fire alarm device</td><td>PASS</td></tr> <tr><td>7.11 Delays to outputs</td><td>PASS</td></tr> <tr><td>7.12 Dependencies on more than one signal (Type B and C)</td><td>PASS</td></tr> <tr><td>8.3 Fault signals from points</td><td>PASS</td></tr> <tr><td>8.9 Output to warning routing equipment</td><td>PASS</td></tr> <tr><td>9.5 Disabling of addressable points</td><td>PASS</td></tr> <tr><td>10 Test condition</td><td>PASS</td></tr> </tbody> </table>	Essential characteristics	Performance	Performance under fire conditions	PASS	Performance of power supply	PASS	Response delay (response time to fire)	PASS	Operational reliability	PASS	Durability of operational reliability:	temperature resistance	PASS	vibration resistance	PASS	electrical stability	PASS	humidity resistance	PASS	Options provided according to EN 54-2	Performance	7.8 Output to the fire alarm device	PASS	7.11 Delays to outputs	PASS	7.12 Dependencies on more than one signal (Type B and C)	PASS	8.3 Fault signals from points	PASS	8.9 Output to warning routing equipment	PASS	9.5 Disabling of addressable points	PASS	10 Test condition	PASS	<table border="1"> <thead> <tr> <th>Essential characteristics</th> <th>Performance</th> </tr> </thead> <tbody> <tr><td>Performance under fire conditions</td><td>PASS</td></tr> <tr><td>Performance of power supply</td><td>PASS</td></tr> <tr><td>Response delay (response time to fire)</td><td>PASS</td></tr> <tr><td>Operational reliability</td><td>PASS</td></tr> <tr> <td rowspan="4">Durability of operational reliability:</td> <td>temperature resistance</td> <td>PASS</td> </tr> <tr> <td>vibration resistance</td> <td>PASS</td> </tr> <tr> <td>electrical stability</td> <td>PASS</td> </tr> <tr> <td>humidity resistance</td> <td>PASS</td> </tr> <tr> <th>Options provided according to EN 54-2</th> <th>Performance</th> </tr> <tr><td>7.8 Output to the fire alarm device</td><td>PASS</td></tr> <tr><td>7.11 Delays to outputs</td><td>PASS</td></tr> <tr><td>7.12 Dependencies on more than one signal (Type B and C)</td><td>PASS</td></tr> <tr><td>8.3 Fault signals from points</td><td>PASS</td></tr> <tr><td>8.9 Output to warning routing equipment</td><td>PASS</td></tr> <tr><td>9.5 Disabling of addressable points</td><td>PASS</td></tr> <tr><td>10 Test condition</td><td>PASS</td></tr> </tbody> </table>	Essential characteristics	Performance	Performance under fire conditions	PASS	Performance of power supply	PASS	Response delay (response time to fire)	PASS	Operational reliability	PASS	Durability of operational reliability:	temperature resistance	PASS	vibration resistance	PASS	electrical stability	PASS	humidity resistance	PASS	Options provided according to EN 54-2	Performance	7.8 Output to the fire alarm device	PASS	7.11 Delays to outputs	PASS	7.12 Dependencies on more than one signal (Type B and C)	PASS	8.3 Fault signals from points	PASS	8.9 Output to warning routing equipment	PASS	9.5 Disabling of addressable points	PASS	10 Test condition	PASS
Essential characteristics	Performance																																																																																																										
Performance under fire conditions	PASS																																																																																																										
Performance of power supply	PASS																																																																																																										
Response delay (response time to fire)	PASS																																																																																																										
Operational reliability	PASS																																																																																																										
Durability of operational reliability:	temperature resistance	PASS																																																																																																									
	vibration resistance	PASS																																																																																																									
	electrical stability	PASS																																																																																																									
	humidity resistance	PASS																																																																																																									
Options provided according to EN 54-2	Performance																																																																																																										
7.8 Output to the fire alarm device	PASS																																																																																																										
7.11 Delays to outputs	PASS																																																																																																										
7.12 Dependencies on more than one signal (Type B and C)	PASS																																																																																																										
8.3 Fault signals from points	PASS																																																																																																										
8.9 Output to warning routing equipment	PASS																																																																																																										
9.5 Disabling of addressable points	PASS																																																																																																										
10 Test condition	PASS																																																																																																										
Essential characteristics	Performance																																																																																																										
Performance under fire conditions	PASS																																																																																																										
Performance of power supply	PASS																																																																																																										
Response delay (response time to fire)	PASS																																																																																																										
Operational reliability	PASS																																																																																																										
Durability of operational reliability:	temperature resistance	PASS																																																																																																									
	vibration resistance	PASS																																																																																																									
	electrical stability	PASS																																																																																																									
	humidity resistance	PASS																																																																																																									
Options provided according to EN 54-2	Performance																																																																																																										
7.8 Output to the fire alarm device	PASS																																																																																																										
7.11 Delays to outputs	PASS																																																																																																										
7.12 Dependencies on more than one signal (Type B and C)	PASS																																																																																																										
8.3 Fault signals from points	PASS																																																																																																										
8.9 Output to warning routing equipment	PASS																																																																																																										
9.5 Disabling of addressable points	PASS																																																																																																										
10 Test condition	PASS																																																																																																										
Essential characteristics	Performance																																																																																																										
Performance under fire conditions	PASS																																																																																																										
Performance of power supply	PASS																																																																																																										
Response delay (response time to fire)	PASS																																																																																																										
Operational reliability	PASS																																																																																																										
Durability of operational reliability:	temperature resistance	PASS																																																																																																									
	vibration resistance	PASS																																																																																																									
	electrical stability	PASS																																																																																																									
	humidity resistance	PASS																																																																																																									
Options provided according to EN 54-2	Performance																																																																																																										
7.8 Output to the fire alarm device	PASS																																																																																																										
7.11 Delays to outputs	PASS																																																																																																										
7.12 Dependencies on more than one signal (Type B and C)	PASS																																																																																																										
8.3 Fault signals from points	PASS																																																																																																										
8.9 Output to warning routing equipment	PASS																																																																																																										
9.5 Disabling of addressable points	PASS																																																																																																										
10 Test condition	PASS																																																																																																										

Figure 3 - Certifications for SmartLoop1010 control panels



 0051	 0051	 0051																																																																																																									
INIM ELECTRONICS S.R.L. Via Fosso Antico snc - Fraz. Centobuchi 63076 Montepandone (AP) - Italy 09 0051-CPR-0225	INIM ELECTRONICS S.R.L. Via Fosso Antico snc - Fraz. Centobuchi 63076 Montepandone (AP) - Italy 09 0051-CPR-0226	INIM ELECTRONICS S.R.L. Via Fosso Antico snc - Fraz. Centobuchi 63076 Montepandone (AP) - Italy 09 0051-CPR-0227																																																																																																									
EN 54-2:1997 + A1:2006 EN 54-4:1997 + A1:2002 + A2:2006 SmartLoop2080/S Control and indicating equipment with integrated power supply equipment for fire detection and fire alarm systems installed in buildings	EN 54-2:1997 + A1:2006 EN 54-4:1997 + A1:2002 + A2:2006 SmartLoop2080/G Control and indicating equipment with integrated power supply equipment for fire detection and fire alarm systems installed in buildings	EN 54-2:1997 + A1:2006 EN 54-4:1997 + A1:2002 + A2:2006 SmartLoop2080/P Control and indicating equipment with integrated power supply equipment for fire detection and fire alarm systems installed in buildings																																																																																																									
<table border="1"> <thead> <tr> <th>Essential characteristics</th> <th>Performance</th> </tr> </thead> <tbody> <tr><td>Performance under fire conditions</td><td>PASS</td></tr> <tr><td>Performance of power supply</td><td>PASS</td></tr> <tr><td>Response delay (response time to fire)</td><td>PASS</td></tr> <tr><td>Operational reliability</td><td>PASS</td></tr> <tr> <td rowspan="4">Durability of operational reliability:</td> <td>temperature resistance</td> <td>PASS</td> </tr> <tr> <td>vibration resistance</td> <td>PASS</td> </tr> <tr> <td>electrical stability</td> <td>PASS</td> </tr> <tr> <td>humidity resistance</td> <td>PASS</td> </tr> <tr> <th>Options provided according to EN 54-2</th> <th>Performance</th> </tr> <tr><td>7.8 Output to the fire alarm device</td><td>PASS</td></tr> <tr><td>7.11 Delays to outputs</td><td>PASS</td></tr> <tr><td>7.12 Dependencies on more than one signal (Type B and C)</td><td>PASS</td></tr> <tr><td>8.3 Fault signals from points</td><td>PASS</td></tr> <tr><td>8.9 Output to warning routing equipment</td><td>PASS</td></tr> <tr><td>9.5 Disabling of addressable points</td><td>PASS</td></tr> <tr><td>10 Test condition</td><td>PASS</td></tr> </tbody> </table>	Essential characteristics	Performance	Performance under fire conditions	PASS	Performance of power supply	PASS	Response delay (response time to fire)	PASS	Operational reliability	PASS	Durability of operational reliability:	temperature resistance	PASS	vibration resistance	PASS	electrical stability	PASS	humidity resistance	PASS	Options provided according to EN 54-2	Performance	7.8 Output to the fire alarm device	PASS	7.11 Delays to outputs	PASS	7.12 Dependencies on more than one signal (Type B and C)	PASS	8.3 Fault signals from points	PASS	8.9 Output to warning routing equipment	PASS	9.5 Disabling of addressable points	PASS	10 Test condition	PASS	<table border="1"> <thead> <tr> <th>Essential characteristics</th> <th>Performance</th> </tr> </thead> <tbody> <tr><td>Performance under fire conditions</td><td>PASS</td></tr> <tr><td>Performance of power supply</td><td>PASS</td></tr> <tr><td>Response delay (response time to fire)</td><td>PASS</td></tr> <tr><td>Operational reliability</td><td>PASS</td></tr> <tr> <td rowspan="4">Durability of operational reliability:</td> <td>temperature resistance</td> <td>PASS</td> </tr> <tr> <td>vibration resistance</td> <td>PASS</td> </tr> <tr> <td>electrical stability</td> <td>PASS</td> </tr> <tr> <td>humidity resistance</td> <td>PASS</td> </tr> <tr> <th>Options provided according to EN 54-2</th> <th>Performance</th> </tr> <tr><td>7.8 Output to the fire alarm device</td><td>PASS</td></tr> <tr><td>7.11 Delays to outputs</td><td>PASS</td></tr> <tr><td>7.12 Dependencies on more than one signal (Type B and C)</td><td>PASS</td></tr> <tr><td>8.3 Fault signals from points</td><td>PASS</td></tr> <tr><td>8.9 Output to warning routing equipment</td><td>PASS</td></tr> <tr><td>9.5 Disabling of addressable points</td><td>PASS</td></tr> <tr><td>10 Test condition</td><td>PASS</td></tr> </tbody> </table>	Essential characteristics	Performance	Performance under fire conditions	PASS	Performance of power supply	PASS	Response delay (response time to fire)	PASS	Operational reliability	PASS	Durability of operational reliability:	temperature resistance	PASS	vibration resistance	PASS	electrical stability	PASS	humidity resistance	PASS	Options provided according to EN 54-2	Performance	7.8 Output to the fire alarm device	PASS	7.11 Delays to outputs	PASS	7.12 Dependencies on more than one signal (Type B and C)	PASS	8.3 Fault signals from points	PASS	8.9 Output to warning routing equipment	PASS	9.5 Disabling of addressable points	PASS	10 Test condition	PASS	<table border="1"> <thead> <tr> <th>Essential characteristics</th> <th>Performance</th> </tr> </thead> <tbody> <tr><td>Performance under fire conditions</td><td>PASS</td></tr> <tr><td>Performance of power supply</td><td>PASS</td></tr> <tr><td>Response delay (response time to fire)</td><td>PASS</td></tr> <tr><td>Operational reliability</td><td>PASS</td></tr> <tr> <td rowspan="4">Durability of operational reliability:</td> <td>temperature resistance</td> <td>PASS</td> </tr> <tr> <td>vibration resistance</td> <td>PASS</td> </tr> <tr> <td>electrical stability</td> <td>PASS</td> </tr> <tr> <td>humidity resistance</td> <td>PASS</td> </tr> <tr> <th>Options provided according to EN 54-2</th> <th>Performance</th> </tr> <tr><td>7.8 Output to the fire alarm device</td><td>PASS</td></tr> <tr><td>7.11 Delays to outputs</td><td>PASS</td></tr> <tr><td>7.12 Dependencies on more than one signal (Type B and C)</td><td>PASS</td></tr> <tr><td>8.3 Fault signals from points</td><td>PASS</td></tr> <tr><td>8.9 Output to warning routing equipment</td><td>PASS</td></tr> <tr><td>9.5 Disabling of addressable points</td><td>PASS</td></tr> <tr><td>10 Test condition</td><td>PASS</td></tr> </tbody> </table>	Essential characteristics	Performance	Performance under fire conditions	PASS	Performance of power supply	PASS	Response delay (response time to fire)	PASS	Operational reliability	PASS	Durability of operational reliability:	temperature resistance	PASS	vibration resistance	PASS	electrical stability	PASS	humidity resistance	PASS	Options provided according to EN 54-2	Performance	7.8 Output to the fire alarm device	PASS	7.11 Delays to outputs	PASS	7.12 Dependencies on more than one signal (Type B and C)	PASS	8.3 Fault signals from points	PASS	8.9 Output to warning routing equipment	PASS	9.5 Disabling of addressable points	PASS	10 Test condition	PASS
Essential characteristics	Performance																																																																																																										
Performance under fire conditions	PASS																																																																																																										
Performance of power supply	PASS																																																																																																										
Response delay (response time to fire)	PASS																																																																																																										
Operational reliability	PASS																																																																																																										
Durability of operational reliability:	temperature resistance	PASS																																																																																																									
	vibration resistance	PASS																																																																																																									
	electrical stability	PASS																																																																																																									
	humidity resistance	PASS																																																																																																									
Options provided according to EN 54-2	Performance																																																																																																										
7.8 Output to the fire alarm device	PASS																																																																																																										
7.11 Delays to outputs	PASS																																																																																																										
7.12 Dependencies on more than one signal (Type B and C)	PASS																																																																																																										
8.3 Fault signals from points	PASS																																																																																																										
8.9 Output to warning routing equipment	PASS																																																																																																										
9.5 Disabling of addressable points	PASS																																																																																																										
10 Test condition	PASS																																																																																																										
Essential characteristics	Performance																																																																																																										
Performance under fire conditions	PASS																																																																																																										
Performance of power supply	PASS																																																																																																										
Response delay (response time to fire)	PASS																																																																																																										
Operational reliability	PASS																																																																																																										
Durability of operational reliability:	temperature resistance	PASS																																																																																																									
	vibration resistance	PASS																																																																																																									
	electrical stability	PASS																																																																																																									
	humidity resistance	PASS																																																																																																									
Options provided according to EN 54-2	Performance																																																																																																										
7.8 Output to the fire alarm device	PASS																																																																																																										
7.11 Delays to outputs	PASS																																																																																																										
7.12 Dependencies on more than one signal (Type B and C)	PASS																																																																																																										
8.3 Fault signals from points	PASS																																																																																																										
8.9 Output to warning routing equipment	PASS																																																																																																										
9.5 Disabling of addressable points	PASS																																																																																																										
10 Test condition	PASS																																																																																																										
Essential characteristics	Performance																																																																																																										
Performance under fire conditions	PASS																																																																																																										
Performance of power supply	PASS																																																																																																										
Response delay (response time to fire)	PASS																																																																																																										
Operational reliability	PASS																																																																																																										
Durability of operational reliability:	temperature resistance	PASS																																																																																																									
	vibration resistance	PASS																																																																																																									
	electrical stability	PASS																																																																																																									
	humidity resistance	PASS																																																																																																									
Options provided according to EN 54-2	Performance																																																																																																										
7.8 Output to the fire alarm device	PASS																																																																																																										
7.11 Delays to outputs	PASS																																																																																																										
7.12 Dependencies on more than one signal (Type B and C)	PASS																																																																																																										
8.3 Fault signals from points	PASS																																																																																																										
8.9 Output to warning routing equipment	PASS																																																																																																										
9.5 Disabling of addressable points	PASS																																																																																																										
10 Test condition	PASS																																																																																																										

Figure 4 - Certifications for SmartLoop 2080 control panels

Declarations of performance, declarations of compliance and certificates relating to the products mentioned in this manual can be downloaded from the following website:

www.inim.biz/certifications

2.12 Warranty

INIM Electronics s.r.l. warrants that for a period of 24 months from the date of commissioning, the product shall be free of defects in materials and workmanship. The warranty applies only to defects in parts and workmanship relating to normal use. It does not cover:

- Improper use or negligence
- Damage caused by fire, flood, wind or lightning
- Vandalism
- Fair wear and tear

INIM Electronics s.r.l. shall, at its option, repair or replace any defective products. Improper use, that is, use for purposes other than those mentioned in this manual will void the warranty. For the full details and conditions regarding the warranty, refer to your purchase order.

2.13 Safety laws

The aim of the instructions in this section is to ensure that the device is installed and handled properly. It is assumed that anyone who handles this apparatus is familiar with the contents of this chapter.

2.13.1 Compliancy

The design and manufacture of the SmartLoop panel comply with EN 54-2 *Fire detection and signaling systems - Control and signaling panels*.

The power supply unit has been especially designed and manufactured in full compliance with EN 54 part 4 *Fire detection and fire alarm systems - Power supply equipment*.

2.13.2 Managing electronic devices

The normal motions of any person may generate electrostatic potential of thousands of volts. Discharge of this current through semiconductor devices during handling may cause serious damage which although may not be immediately evident may reduce the reliability of the circuits.

If located in their housings, the electronic circuits of INIM Electronics products are highly immune to electrostatic discharge.

- Do not expose the circuits to damage by removing the modules unnecessarily from their housings.
- When removing or handling the boards, hold the board edges only.
- Do not touch the electronic components, the printed circuits or the metal parts of the connectors.
- Do not hand the board to another person without first ensuring that both of you have the same electrostatic potential. This can be achieved by simply shaking hands.
- Place the board on an anti-static surface or a conductor surface with the same potential.

Further information regarding procedures relating to safety when working with electronic devices can be found in EN 61340-5-1 e CLC/TR 61340-5-2.

2.13.3 Setting up the system

In order to provide adequate protection and instructions for proper use, security professionals (Installers and maintenance technicians) must be familiar with the operating procedure of this device.

Please read the instructions carefully before installing and setting up this product.

Before first power-up, be sure that the earth connection has been completed properly on the respective terminal.

The recommended minimum wire cross section for the earth connection is 2.5 mm², unless otherwise stated in accessory documentation.

2.13.4 Replacement and disposal of used devices

Replacement

When replacing obsolete devices, disconnect the devices concerned then complete the connections of the new devices in compliance with the instructions printed on the respective leaflets.

Contact your local municipal offices for information regarding the disposal of used electronic devices.

Disposal

Do not burn used electronic devices, or allow them to pollute the environment (countryside, rivers, etc.). Electronic devices must be disposed of in a safe environment-friendly way. In order to avoid short-circuits, take all the necessary precautions when removing used batteries. Contact your local municipal offices for information regarding the disposal of batteries.

Device management

3.1 Transport of goods

Care must be taken to avoid accidental damage during transport. The boxes should be placed in such a way as to avoid knocks and falls, and special care must be taken to protect the devices from extreme heat and/or cold.

3.2 Environmental conditions

Temperature limits:

- -10° / +55°C for transport and storage
- -5° / +40°C operating temperature

3.3 Unpacking the device

On receipt the goods must be unpacked with care. All waste packaging materials must be disposed of in compliance with the local laws and bylaws in force.

The metal enclosure of the device is packed carefully inside the cardboard box.

Note: *All waste packaging must be disposed of in full respect of the local laws in force.*

3.3.1 Inside the box

Inside the box you will find:

- Metal enclosure containing the mother board
- Installation manual
- Plastic bag containing:
 - 5 resistors @ 47KOhm 1/4W
 - 5 diodes @ 1A 1000V 1N4007
 - 1 non-rechargeable CR2032 lithium battery
 - 1 ferrite
 - keys
 - battery connection wires
 - eyelet terminal for connection to earth
- Thermal probe for battery-charge optimization based on the battery temperature.

Attention: **The 2032 lithium battery guarantees data retention. This battery must be fitted properly into its housing (refer to *paragraph 4.2 - [H]*) with the "+" sign towards you.**

The package does not include:

Batteries, SmartLeague software programming CD. These items must be purchased separately. Be sure you have these items on hand before starting the installation procedure.

Attention: **In order to validate the IMQ-SISTEMI DI SICUREZZA certification and comply with EN 54-4 standard requirements, installation of a thermal probe is essential. Be sure you have this item on hand before starting the installation procedure.**

Technical description

4.1 Control panel

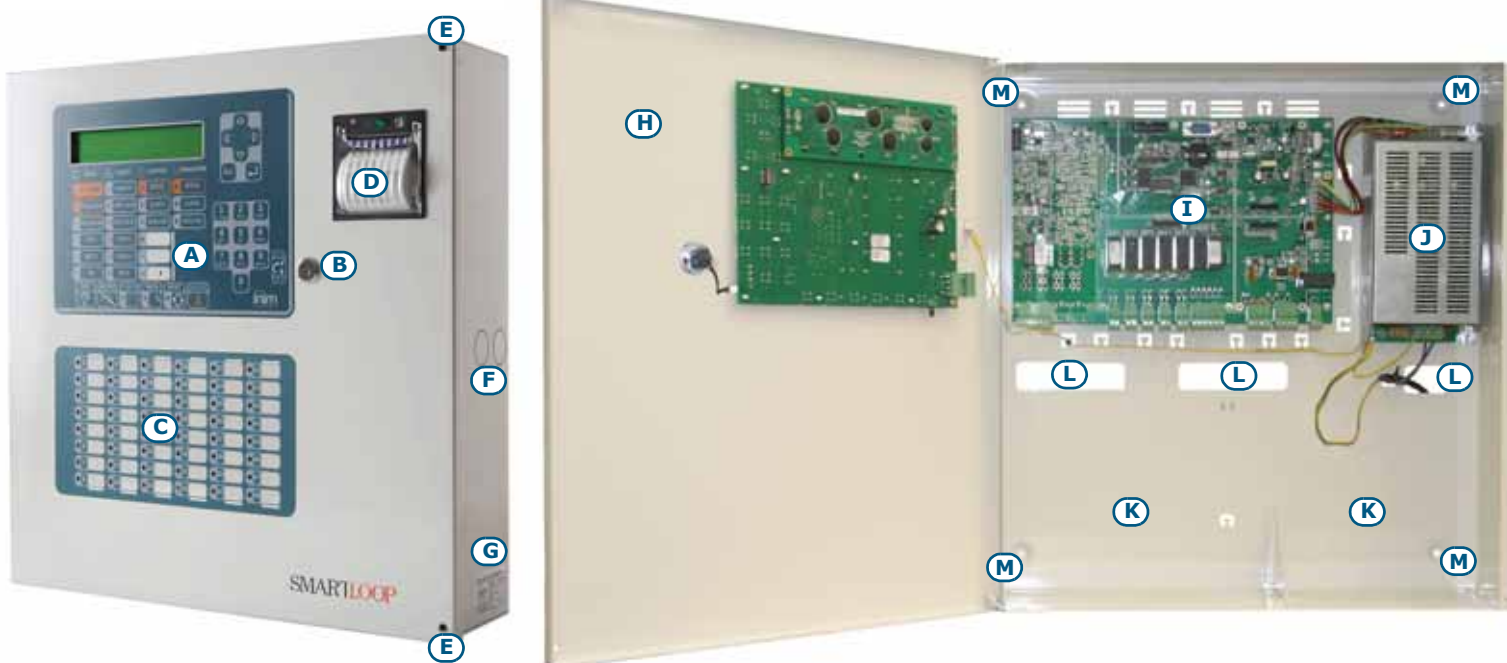

Figure 5 - External and internal parts of the Control panel

[A]	Frontplate with display, keys and signalling LEDs	SmartLoop/P and SmartLoop/G only
[B]	Slot for level 2 access key	
[C]	LED Panel	SmartLoop/P only
[D]	SmartLoop/PRN Thermal printer	
[E]	Securing screws for the front cover	All models
[F]	Cable entries (located on all sides of the enclosure)	
[G]	Data label	
[H]	Frontplate	
[I]	About the motherboard	
[J]	Power supply module	
[K]	Backup battery housing	
[L]	Cable entry	
[M]	Anchor screw hole	

4.2 The motherboard

The SmartLoop motherboard has a 32 bit microprocessor that controls all the control panel functions, and 2 peripheral microprocessors (one per loop) that manage communications with the system peripherals.

INIM’s R & D professionals have developed and designed the SmartLoop motherboard using ground-breaking new generation fire technologies that ensure maximum precision and performance. Deployment

of the most advanced reflow technology ensures high-noise immunity and extreme accuracy. Each connection terminal is protected against electrical surges and is high-noise immune capable. All terminals on the motherboard are clearly marked and easily identifiable.

The motherboard has been especially designed to accommodate with ease the various SmartLoop attachment boards.

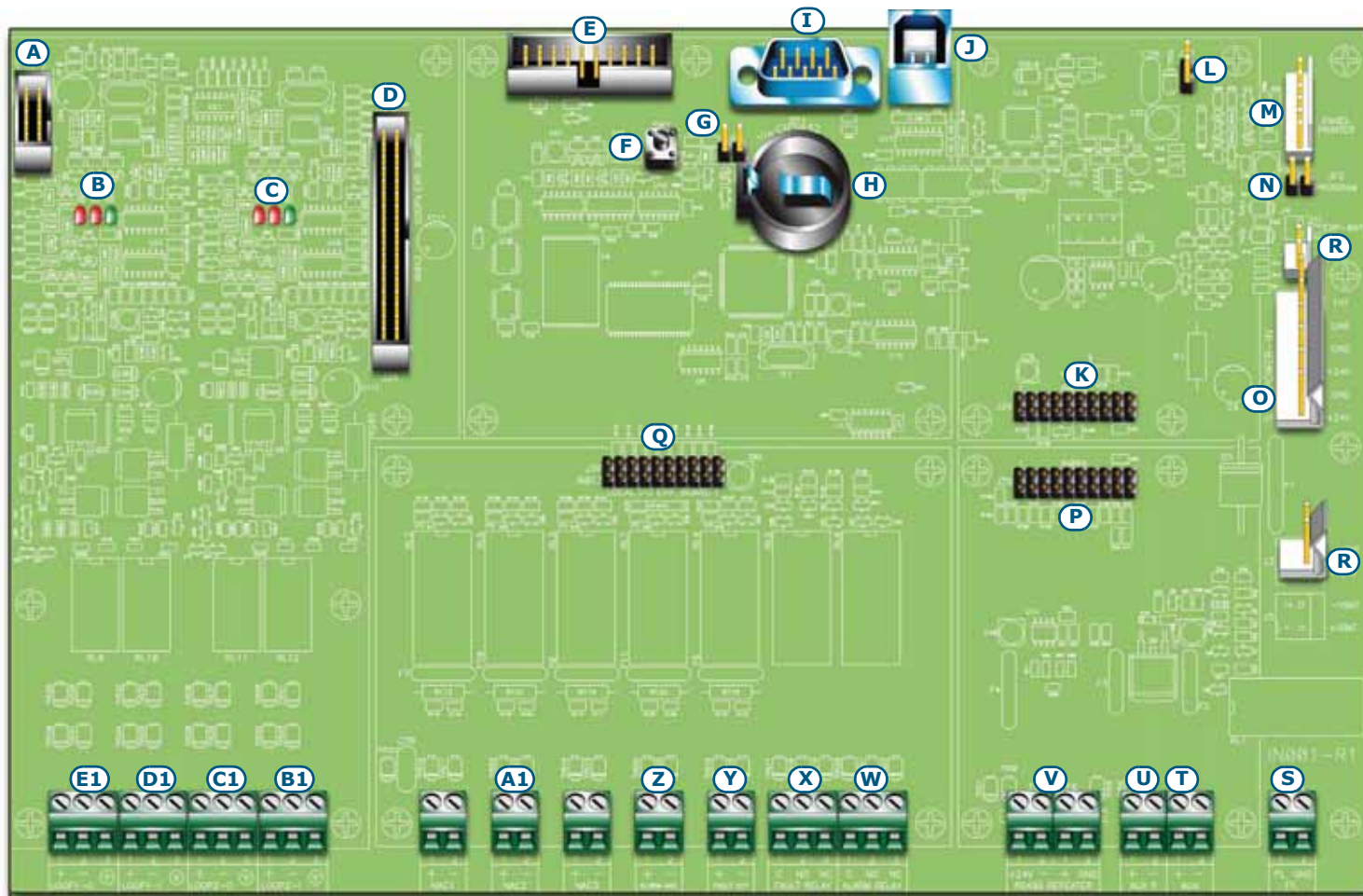

Figure 6 - About the motherboard

[A]	Connector for the connection with the display board (located on the frontplate)
[B]	Loop 1 status LED
[C]	Loop 2 status LED
[D]	SmartLoop/2L board connector
[E]	SmartLAN board connector
[F]	Microprocessor reset button
[G]	Memory jumper (if removed and the panel is switched Off, the system will restore to factory default settings)
[H]	Memory battery (3V lithium battery)
[I]	COM RS232 connector (DB9 maschio)
[J]	USB connector (type B)
[K]	SmartLoop/PSTN plug-in module connector
[L]	Clear ground-fault jumper (removal of this jumper clears ground faults)
[M]	On-panel thermal printer connector
[N]	Programming jumper (removal of this jumper blocks access to programming)
[O]	Switching power-supply module connector
[P]	SmartLoop/NET plug-in module connector
[Q]	SmartLoop/INOUT plug-in module connector
[R]	Reserved connectors DO NOT USE

[S]	PL	PL and GND terminals for disconnected-battery signalling. In the event of primary power failure and battery shutdown (complete blackout), the PL terminal will be connected to GND. In the opposite condition, the PL terminal will be disconnected.
[T]	AUX	24V output for the external power load, protected by a 1.8A self-resettable fuse
[U]	AUX-R	24V output for external loads, protected by a 1.8A self-resettable fuse (with "Power Cutoff" during reset.) Suitable for powering devices which require power loss in order to reset (e.g. beam detectors)
[V]	RS485 REPEATER	RS485 Bus terminals for repeater connections (accommodate up to 14 Repeaters)
[W]	ALARM RELAY	Alarm relay (voltage free)
[X]	FAULT RELAY	Fault relay (voltage free)
[Y]	FAULT OUT	Supervised fault output protected by 1A fuse
[Z]	ALARM NAC	Supervised alarm NAC output protected by 1A self-resettable fuse
[A1]	NAC1, NAC2, NAC3	Programmable supervised NAC outputs protected by resettable 1A fuses
[B1]	LOOP2-I	Loop 2 Input terminals
[C1]	LOOP2-O	Loop 2 Output terminals
[D1]	LOOP1-I	Loop 1 Input terminals
[E1]	LOOP1-O	Loop 1 Output terminals

4.2.1 Loop status LED

The loop status LEDs (*paragraph 4.2 - [B]* and *paragraph 4.2 - [C]*) indicate that the control panel is interrogating its peripheral devices. The indications will help you (the installer) to understand which protocol is being used and whether or not the interrogated devices have responded.

- The green LED on the right will flash each time a loop device responds. The control panel interrogates its devices at regular intervals, starting from address 1 through to the last address (for information regarding which devices can be connected to the loop, refer to *Appendix A*, *Appendix B* and *Appendix C*).
- The red LED in the centre will blink each time a command is sent through the loop for a device using either Enea (*Appendix A*) or Argus (*Appendix B*) protocol.
- The red LED on the right will flash each time a command is sent through the loop for a device using Apollo (*Appendix C*) protocol.

Under normal operating conditions, the red protocol LED will blink rapidly and the green response LED will flicker in accordance with the response from the various devices. The flickering phase depends on the number of devices connected to the loop. The more devices the longer the LED will flicker.

4.3 LED Panel

SmartLoop/P control panel models are equipped with a LED panel (located on the front of the control panel enclosure) which is connected to the keypad/display board (*paragraph 4.1 - [C]*).

This panel has 48 red LEDs which provide one or more signals (configured during the programming phase). The On/Off logic of each LED can be set up individually.

4.4 Switching power supply

The switching power supply is attached to the backplate of the metal enclosure:

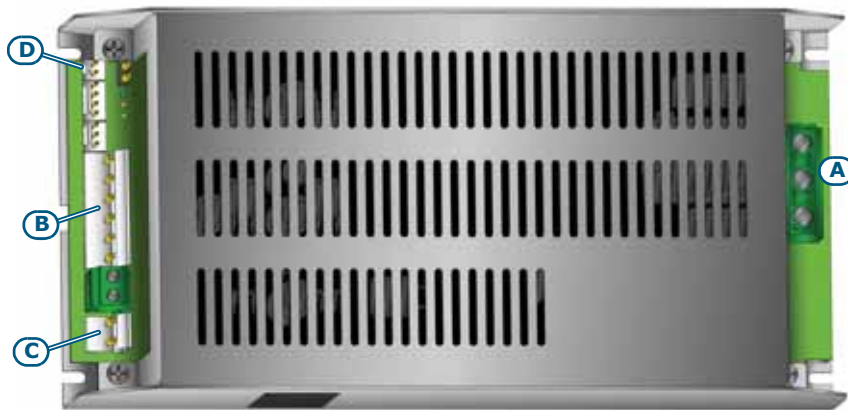

	Mains input terminal board
[A]	
[B]	Mother board connector
[C]	Battery connector
[D]	Thermal probe connector

4.5 Technical specifications

AC power	230V \sim (-15% / +10%) 50/60Hz
Maximum current draw 230V	1.1 A
Nominal output voltage	27.6V ---
Output voltage	from 19 to 27.6 V
Maximum output current	5.2 A
$I_{\text{max. a}}$	4 A
$I_{\text{max. b}}$	4 A
Maximum battery current emission during primary power failure	4 A
Maximum current for external loads and accessory devices	3.8 A
Panel Current draw (motherboard + LCD screen on the frontplate)	
- standby	200 mA
- from battery in the event of mains failure	80 mA
- maximum battery-charge current	1.2 A
Battery specifications	2 x 12V, 17 Ah
Brand and type	YUASHA NP 7 -12 FR or NP 17 -12-FR (or equivalent) with UL94-V2 flame class enclosure or higher
Maximum internal resistance of the batteries ($R_{i \text{ max}}$)	1 Ohm
Battery shutdown tension	19 V
Maximum output ripple	1%
Operating temperature	From -5° to +40° C
Internal fuse of switching power supply module	T 3.15A 250V
Isolation class	I
Enclosure protection class (EN 60529)	IP30
Dimensions (Height x Length x Depth)	48 x 47 x 13.5 cm
Weight without battery	8 Kg
Attachment board current draw	
SmartLoop/2L (2 Loop expansion board)	stby: 20mA MAX:70mA
SmartLoop/INOUT (6 input/output expansion board)	stby:40mA MAX:300mA
SmartLoop/NET (Token-ring network adapter board)	stby: 40mA MAX:40mA

SmartLoop/PSTN (PSTN dialler)	stby:20mA MAX:60mA
SmartLAN (Ethernet board)	stby:200mA MAX:200mA
SmartLoop/LED (48 LED board)	stby:40mA MAX:80mA
SmartLoop/PRN (on-panel thermal printer)	stby:0A MAX:1A
SmartLetUSee/LCD (LCD repeater)	stby: 40mA MAX:50mA
SmartLetUSee/LED (LED repeater)	stby:5mA MAX:50mA
Absolute maximum terminal ratings	
Motherboard	
Loop output terminals	Max. 0.5A each loop
NAC1, NAC2, NAC3, alarm NAC, fault output	1.3A MAX
Fault relay, alarm relay	dry contact 5A @ 30V \overline{DC} max
RS485 BUS	1.8A MAX
AUX, AUX-R	1.8A MAX
Current ripple on AUX and AUX-R outputs	1% MAX
PL	Normally Open Contact 5A @ 30V \overline{DC} MAX
SmartLoop/INOUT	
on each CH	0.9A MAX
PIN code to access default settings	00004

Accessory devices

5.1 Attachment boards

The motherboards accommodates the following attachment boards:

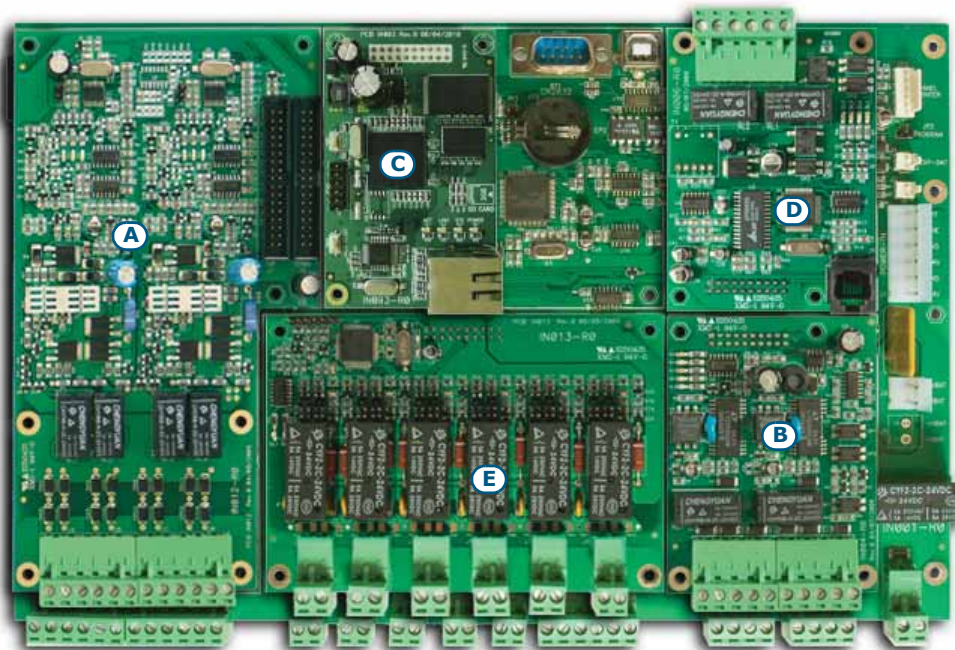

Figure 7 - The motherboard accessorized with attachment boards

[A]	Up to 3 SmartLoop/2L loop expansion boards (2080 expandable models only)
[B]	1 SmartLoop/NET network board for the creation of a control panel network environment (Hornet technology)
[C]	1 SmartLAN LAN board for connection to an Ethernet (Janus technology)
[D]	1 SmartLoop/PSTN telephone board for PSTN land line connection
[E]	1 SmartLoop/INOUT input/output expansion board (provides 6 Inputs/Outputs)

SmartLoop/P models also accommodate the SmartLoop/PRN thermal printer (to be located on the frontplate). This device provides real-time printouts and inquiry printout.

Refer to the respective paragraphs for the board descriptions.

5.1.1 The SmartLoop/2L board

All expandable SmartLoop control panels have 2 on-board loops expandable to 8 by means of 3 SmartLoop/2L expansion boards. The non-expandable SmartLoop 1010 version have 1 loop only.

The loops accommodate either 126 or 240 fire detection/signalling devices, depending on the selected protocol (refer to *Appendix A*, *Appendix B* and *Appendix C*).

Due to electrical incompatibility, different brand devices (i.e. devices using different protocols) cannot co-exist on the same loop. However, the loops can be programmed separately in such way as to allow the system to manage different brand devices on different loops.

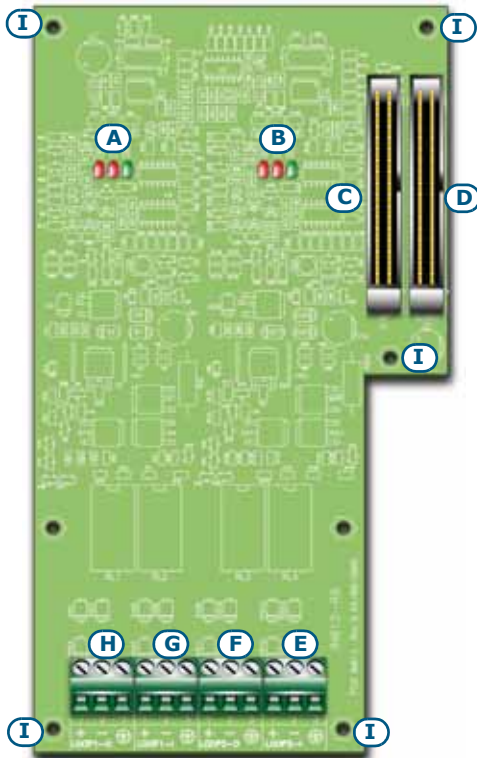

[A]	Loop 1 status LED	refer to <i>paragraph 4.2.1 Loop status LED</i>
[B]	Loop 2 status LED	
[C]	Connector for the connection wire of the successive SmartLoop/2L board (up to 3 boards)	
[D]	Connector for the connection wire of the mother board or previous SmartLoop/2L board	
[E]	Loop 2 Input terminals	
[F]	Loop 2 Output terminals	
[G]	Loop 1 Input terminals	
[H]	Loop 1 Output terminals	
[I]	Screw locations	

Figure 8 - SmartLoop/2L board

The SmartLoop/2L package includes:

- A cable for the connection to the motherboard
- Two split ferrite cores for the loop output wires
- 5 anchor screws
- 5 spacers

5.1.2 The SmartLoop/NET board

The SmartLoop/NET board allows you to create a token-ring capable of managing 30 SmartLoop control panels via a 3 -pole cable.

The network must be wired as a ring network with a maximum cable length between each panel of 2000 metres, in this way, the network will be fault tolerant (HorNet technology). Using a supplementary 2-pole cable (5 poles in all), you can create a protection ring which can pass alarm conditions, coming from a fire control panel with microprocessor fault, through the ring.

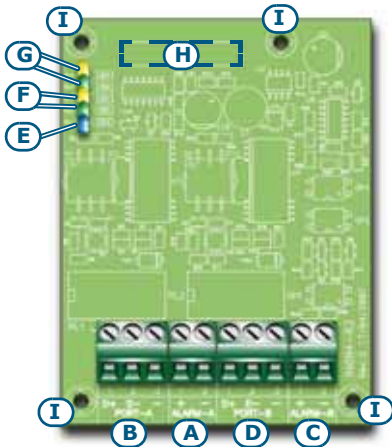

[A]	A terminals for the protection-ring connection (to be connected to Alarm-B of the successive control panel)
[B]	Communication Port A (to be connected to Port-B of the successive control panel)
[C]	B terminals for the protection ring connection (to be connected to Alarm-A of the previous control panel)
[D]	Communication Port B (to be connected to the Port-A terminals of the previous control panel)
[E]	Blue LED (indicates the In Service/Out of Service status of the SmartLoop/NET board). If this LED is Off, the panel is isolated from the network.
[F]	2 Port A status LEDs (green and yellow)
[G]	2 Port B status LEDs (green and yellow)
[H]	Interface to motherboard plug (located on the reverse side of the board)
[I]	Screw locations

Figure 9 - SmartLoop/NET board

Danger: In order to allow the ring to operate properly, the Port-B and Alarm-B terminals must be connected to the successive Port-A and Alarm-A terminals.

The SmartLoop/2L package includes:

- 4 anchor screws
- 4 spacers

5.1.3 The SmartLAN board

The SmartLAN board connects to any Ethernet network and allows remote access (via Internet) to the fire control system (allows connection to all the fire control panels in the token-ring network).

- **SmartLAN** – This board can send detailed e-mails for each event and real-time event reports over TCP/IP. It provides a web server for web-based access to the system via browser (Internet Explorer, Firefox, Opera, etc.).

This board allows you to carry out remote programming operations (upload/download), manage the system via INIM's **SmartLook** software application and also manage Dynamic DNS.

- **SmartLAN/SF** – This board allows you to carry out remote programming operations (upload/download), manage the system via INIM's **SmartLook** software application.

To access the configuration phase of the SmartLAN board, the default IP address is: **192.168.1.92**

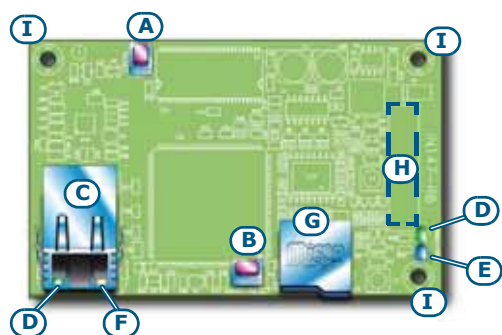

[A]	Microprocessor Reset button
[B]	Programming reset button
[C]	Ethernet port
[D]	Power-supply indicator LED
[E]	Motherboard communication LED (SYS)
[F]	ACT LED (indicates data transmission via Ethernet)
[G]	Housing for the microSD-card for e-mail attachment storage
[H]	Interface to motherboard plug (located on the reverse side of the board)
[I]	Screw locations

Figure 10 - The SmartLAN board

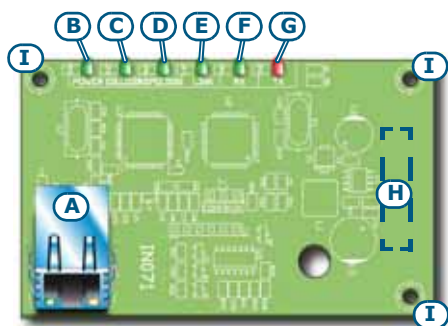

[A]	Ethernet port
[B]	Power supply LED
[C]	Collision LED (Network collision)
[D]	Connection speed LED @ 100Mbps
[E]	Collision LED (Network collision)
[F]	Packet reception via RS485 BUS LED
[G]	Packet reception via RS485 BUS LED
[H]	Interface to motherboard plug (located on the reverse side of the board)
[I]	Screw locations

Figure 11 - The SmartLAN/SF board

Each SmartLAN or SmartLAN/SF board comes with:

- 3 anchor screws
- 3 spacers

5.1.4 The SmartLoop/PSTN board

The SmartLoop/PSTN board allows the SmartLoop fire control panel to use the land line (PSTN). It manages (and monitors) 2 lines and uses the most widely used reporting protocols (SIA, Contact ID, etc.).

It has an 8-slot audio memory for up to eight voice call messages. Completely managed by its on-board microcontroller, it generates emergency calls in the event of a CPU fault, and also any alarm calls triggered during the CPU fault.

	[A]	L.I. terminals for the internal phone-line connection. The signals from the L.E. terminals (external landline) are diverted to these terminals, thus allowing the connected telephone devices to use the land line.
	[B]	L.E. Terminals for the PSTN telephone connection
	[C]	L.B. Terminals for the backup line (a secondary line to be used in the event of "primary line-down" conditions)
	[D]	Red LED for backup phone-line trouble signals
	[E]	Red LED for main phone-line trouble
	[F]	Green Activity LED (indicates data exchange between the SmartLoop/PSTN board and the motherboard)
	[G]	Yellow Line-engaged LED (goes On when the PSTN board hooks the PSTN line)
	[H]	Phone plug-in connector (for recording voice messages using a normal phone)
	[I]	Interface to motherboard plug (located on the reverse side of the board)
	[J]	Screw locations

Figure 12 - The SmartLoop/PSTN board

The SmartLoop/PSTN package includes:

- 4 anchor screws
- 4 spacers

5.1.5 The SmartLoop/INOUT board

The SmartLoop/INOUT board provides 6 outputs (CH1 - CH6). Each of these can be configured as:

- Supervised output (NAC – 1A max.)
- Supervised Input
- Conventional detector line
- Gas detector line

During the programming phase, you can program the events which will activate the outputs and the actions generated by the inputs.

Each SmartLoop/INOUT package contains:

- 4 anchor screws
- 4 spacers
- Resistors and diodes

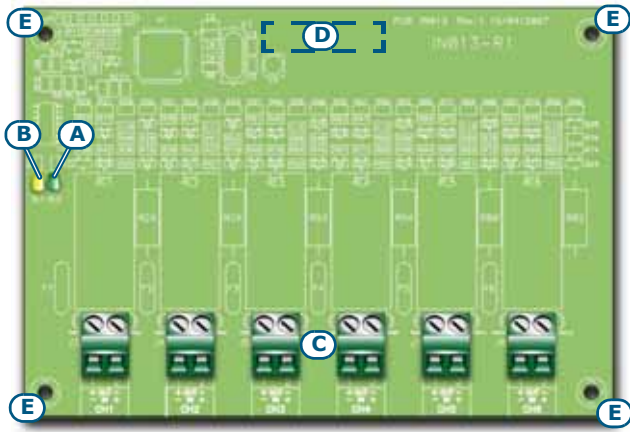

[A]	Green Activity LED
[B]	Yellow Fault LED (fault on at least 1 of the 6 board channels)
[C]	Input/Output terminals
[D]	Interface to motherboard plug (located on the reverse side of the board)
[E]	Screw locations

Figure 13 - The SmartLoop/PSTN board

5.2 SmartLoop/PRN Printer

The SmartLoop/PRN thermal printer module uses 82mm thermal roll paper and can be connected directly to the motherboard (connector cable included). It provides a continuous real-time printout of events and/or date to date inquiry printouts. It can also printout complete reports for each separate loop, containing information related to the status of each detector/module (dust accumulation, loop communication quality, real-time values, etc.).

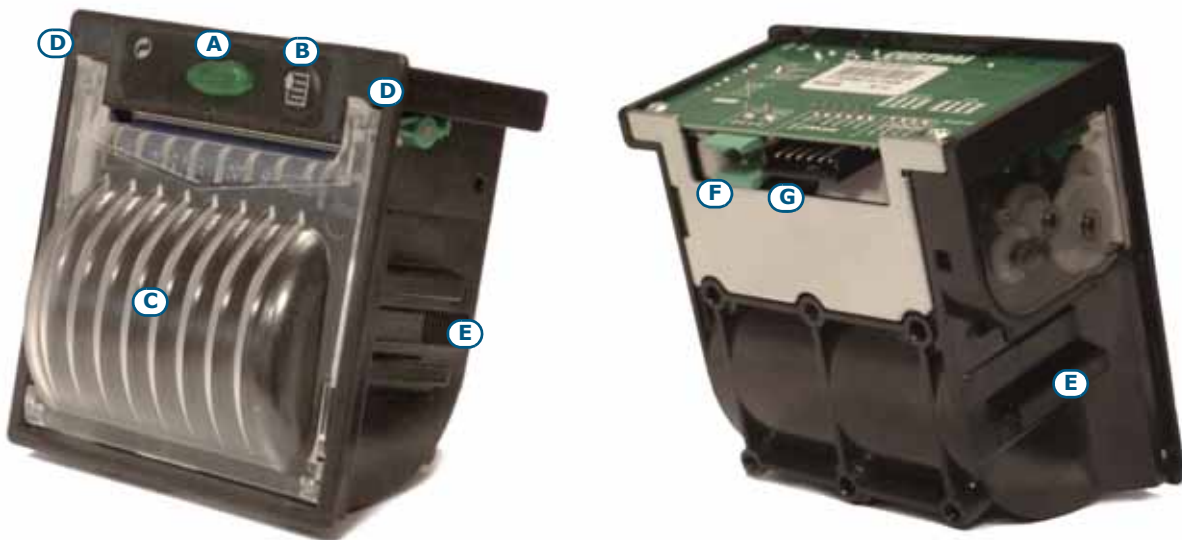

Figure 14 - The SmartLoop/PRN module

[A]	Status LED and button to open the paper-roll housing
[B]	Paper roll button
[C]	Paper roll housing
[D]	Paper-roll housing fastener
[E]	Guide for anchor hook to the panel
[F]	Power supply terminals (24V) to be connected to the red and black wires of the supplied wire
[G]	Flat cable board to motherboard connector (included)

The SmartLoop/PRN module comes with:

- A cable for the connection to the motherboard
- Cable ties
- 2 hooks
- Paper roll

5.3 The SmartLetUSee/LCD and SmartLetUSee/LED Repeater panels

The SmartLoop fire control panel supports 14 SmartLetUSee/LCD remote Repeater panels. These remote panels can be connected to the RS485 bus on the motherboard by means of a 4-pole cable. Repeater panels replicate all the SmartLoop fire system data and allow authorized personnel to access and control the system in accordance with access authorization (access requires code entry).

If you open the repeater enclosure, the rear side of the electronic board (which is attached to the frontplate) will be on view. Following is a description of the parts which will be used during the installation phase:



Figure 15 - The SmartLetUSee/LCD module

[A]	SmartLetUSee/LCD	Front of module
[B]	SmartLetUSee/LCD	Back of board
[C]	DIP switches	For the repeater address setting
[D]	RS485 terminals	From the bottom of the figure to the top "+24V - + GND"; for the connection to the RS485 BUS
[E]	EOL terminals	For the setting jumper which indicates the position of the repeater in the system.
[F]	SmartLetUSee/LED terminals	Connector for the SmartLetUSee/LED module

You can connect a SmartLetUSee/LED module to each SmartLetUSee/LCD module by means of the connection wire supplied with the module. The SmartLetUSee/LED provides 48 zone-status LEDs. The On/Off of each LED can be configured individually during the programming phase.

Note: *The SmartLetUSee/LED module can be used only in combination with a SmartLetUSee/LCD module.*

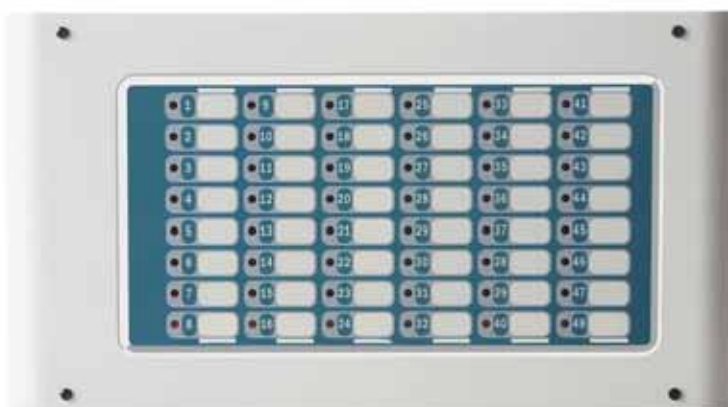

Figure 16 - The SmartLetUSee/LED module

Installation

Danger: **Installation of this fire control panel must be carried out in full respect of the local fire codes, laws and bylaws in force, and in accordance with the instructions and guidelines herein.**

The cable glands must be rated UL94-V1 flame class (or higher)

6.1 Choosing the mounting location

This Fire control panel should be located in a place that is:

- Dry
- Far from electromagnetic interference (electrical equipment, heating units, air-conditioning units, radio transmitters, etc.)

The mounting location must satisfy all the requirements of the respective Fire Code, laws and bylaws in force.

6.2 Installation flow, guidelines and testing

1. Lay the cables
2. Connect all the loop and peripheral devices.
3. Install system peripherals
4. Mount the panel
5. Install accessory modules (if necessary)
6. Power up the system
7. Test the system (network, repeaters, ancillary and signaling devices).

Danger: **DO NOT apply mains power until all connections have been completed.**

6.2.1 Wall mounting the panel

1. Prepare the wall for the four 8mm anchor screws (stop screws) which must be positioned in correspondence with the holes on the backplate of the metal enclosure (*paragraph 4.1 - [M]*).

Danger: **Care must be taken not to drill in the vicinity of electrical wiring, heating ducts and plumbing.**

Note: *Choose anchor screws which are capable of supporting 20kg and which are suitable for the characteristics of the wall.
Ask for professional advice with regard to the best type of anchor screw for the wall concerned.*

2. Remove the knockout of the cable entry you intend to use (you can choose from knockouts on the sides of the enclosure).
3. Fit a cable gland (not included) to the wire entry.
4. Using the 4 anchor screws, attach the enclosure securely to the wall.
5. Pull the cables through the cable entry.
6. Connect ant attachment boards to the motherboard.
7. Connect the SmartLoop/PRN module (if used) to the motherboard (*paragraph 5.2 SmartLoop/PRN Printer*)
8. Complete the connections.

6.2.2 Connecting attachment boards

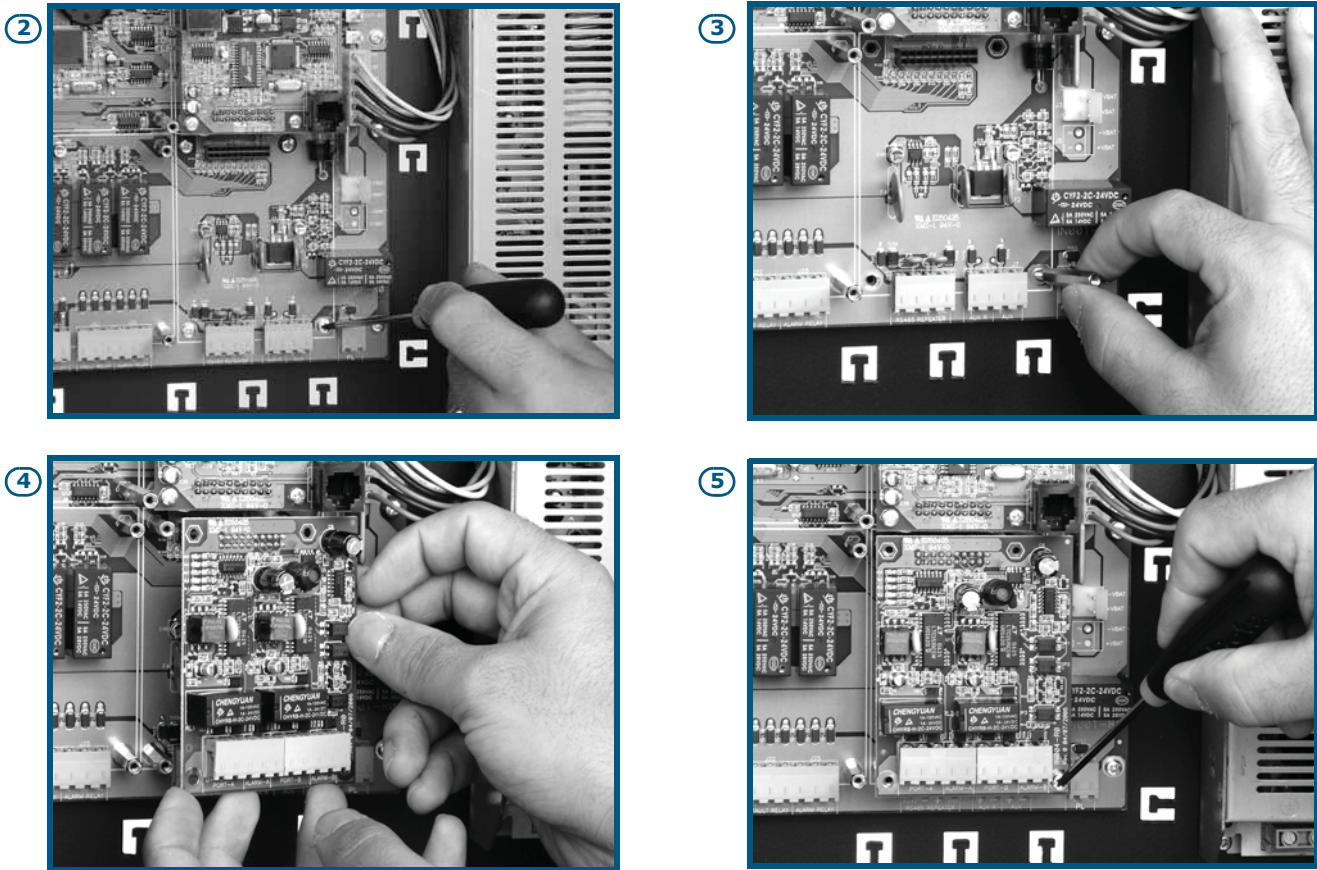

Figure 17 - Connecting attachment boards

1. Find the attachment board location on the motherboard (refer to *Figure 7 - The motherboard accessorized with attachment boards*).
If you are installing a SmartLoop/2L board, insert one end of the flat cable (included) into the respective connector on the motherboard (*paragraph 4.2 - [D]*).
2. Remove the relative screws from the motherboard.
3. Screw the metal spacers into place (included).
4. Position the accessory board on the supports and check that the accessory board connector is properly inserted.
5. Using the previously-removed screws, secure the attachment board in place.
6. If you are installing a SmartLoop/2L board, using the free end of the flat cable (included), connect the accessory board to the motherboard.

6.3 Connecting the SmartLoop/PRN printer module

1. Unscrew the nuts from the screws which secure the printer-housing plate in place (*paragraph 4.1 - [D]*) then remove the plate.
2. Working from the front of the enclosure (door closed), insert the Printer into its location.
3. Holding the printer module firmly in place, open the enclosure door and position the hooks on the guide (*paragraph 5.2 - [E]*), ensure that the module is firmly positioned.
4. Connect the printer wire to the terminals on the reverse side of the module (*paragraph 5.2 - [F]* and *paragraph 5.2 - [G]*) and to the motherboard via the respective connector (*paragraph 4.2 - [M]*).
5. Use the cable ties and plastic cable hooks (included in the SmartLoop/PRN kit) where necessary on the reverse side of frontplate (above the motherboard), in order to secure the connection wires firmly in place.

Connections

7.1 Note to the Installer regarding wiring and connection compliancy

7.1.1 Two wire connection

For a system that is EN54 compliant, no more than 32 sensors can be connected when this type of wiring is used.

7.1.2 Four wire connection

For a system that is EN54 compliant, an insulation module must be installed for each group of 32 detectors (refer to *Appendix A*, *Appendix B* and *Appendix C* for information regarding the devices with built-in isolators).

Guidelines

Danger: If you are using a 2 wire connection, no more than 32 detectors can be connected to the loop.

If you are using a 4 wire connection, T junctions are prohibited, that is unless the maximum number of devices that risk isolation during any type loop fault does not exceed 32.

If the system loop devices do not have built-in isolators, you must install an isolator for each group of 32 detectors. Refer to *Appendix A*, *Appendix B* and *Appendix C* for further details.

All circuits should be wired using the local country Fire Code compliant method.

7.2 About the circuitry

The fire alarm system circuitry is critical to the safety and well being of the building occupants. It is considered an essential communication path during evacuation or relocation of persons during a fire or emergency situation. During such an event, it is critical for fire safety equipment such as fire alarm signaling equipment to remain operational for a specified amount of time. Therefore, all circuits are to be wired using the local country Fire Code compliant method.

7.2.1 Guidelines

- The fire alarm system circuitry must not be commingled without proper separation, and must be kept separate from all other wiring.
- Junction boxes are required at splice points. All Junction boxes must be installed using the local country Fire Code compliant method.
- Any wiring inside the control panel enclosure must be secured to the cable hooks on the backplate of the enclosure using plastic cable ties.
- The mains power supply cable must enter the control panel enclosure through the appropriate cable entry and must not cross any other wires. The mains power supply cable must be secured to the cable hook on the back box by means of a plastic cable tie.

7.3 Loop Connections

The loops accommodate a vast array of fire system devices (detectors, manual call points, fire buttons, Input and Output modules, etc.).

For a detailed description of the devices the loop accepts, refer to *Appendix A*, *Appendix B* and *Appendix C*.

Due to electrical incompatibility, different brand devices (i.e. devices using different protocols) cannot co-exist on the same loop. However, the loops can be programmed separately in such way as to allow the system to manage different brand devices on different loops.

Note: Each loop output conductor must be fitted with a split ferrite core (included), as shown in the figure below.

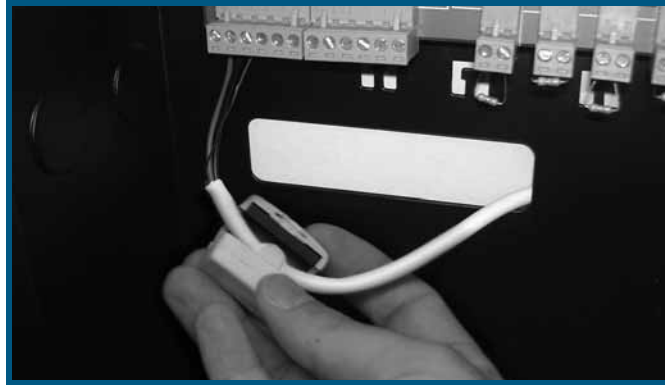

Figure 18 - Attaching the split ferrite core to loop output cables

7.3.1 Loop terminals

LOOP1-O and **LOOP2-O** - loop output (*paragraph 4.2 - [C1]* and *paragraph 4.2 - [E1]*)

- Terminals “+” and “-”: connect all loop devices in parallel to these terminals, in accordance with the specific device instructions.
- Earth terminal “⊕”: connect the shield of the STP cable (2 pole) to this terminal.

Note: *Always leave one end of the shield disconnected.*

LOOP1-I and **LOOP2-I** - loop input (*paragraph 4.2 - [B1]* and *paragraph 4.2 - [D1]*)

- Terminals “+” e “-”: connect the loop return loop wiring to these terminals.
These terminals allow the panel to check the loop integrity. In the event of a single interruption on the circuit, the panel will communicate with the isolated trunk elements via these terminals.
- Earth terminal “⊕”: connect the shield of the STP cable (2 pole) to this terminal.

Note: *Always leave one end of the shield disconnected.*

7.3.2 Loop limitations

Use suitably sectioned shielded twisted cable for the loop wiring. Connect the shield to earth using the earth terminals to one end of the loop only.

In order to allow the loop to function properly, you must section the device connection cable in such a way that any voltage drop along the line does not exceed 8V. The following table shows the minimum dimensions for the loop wiring with regard the distance between the loop output terminals and the most distant device:

up to 500 m	minimum 1 mm ²
up to 1000 m	minimum 1.5 mm ²
up to 1500 m	minimum 2 mm ²
up to 2000 m	minimum 2.5 mm ²

7.3.3 Connecting devices to the Loop

The loop wiring can be completed with 2 wires (open loop) or 4 wires (closed loop) using 2 pole STP.

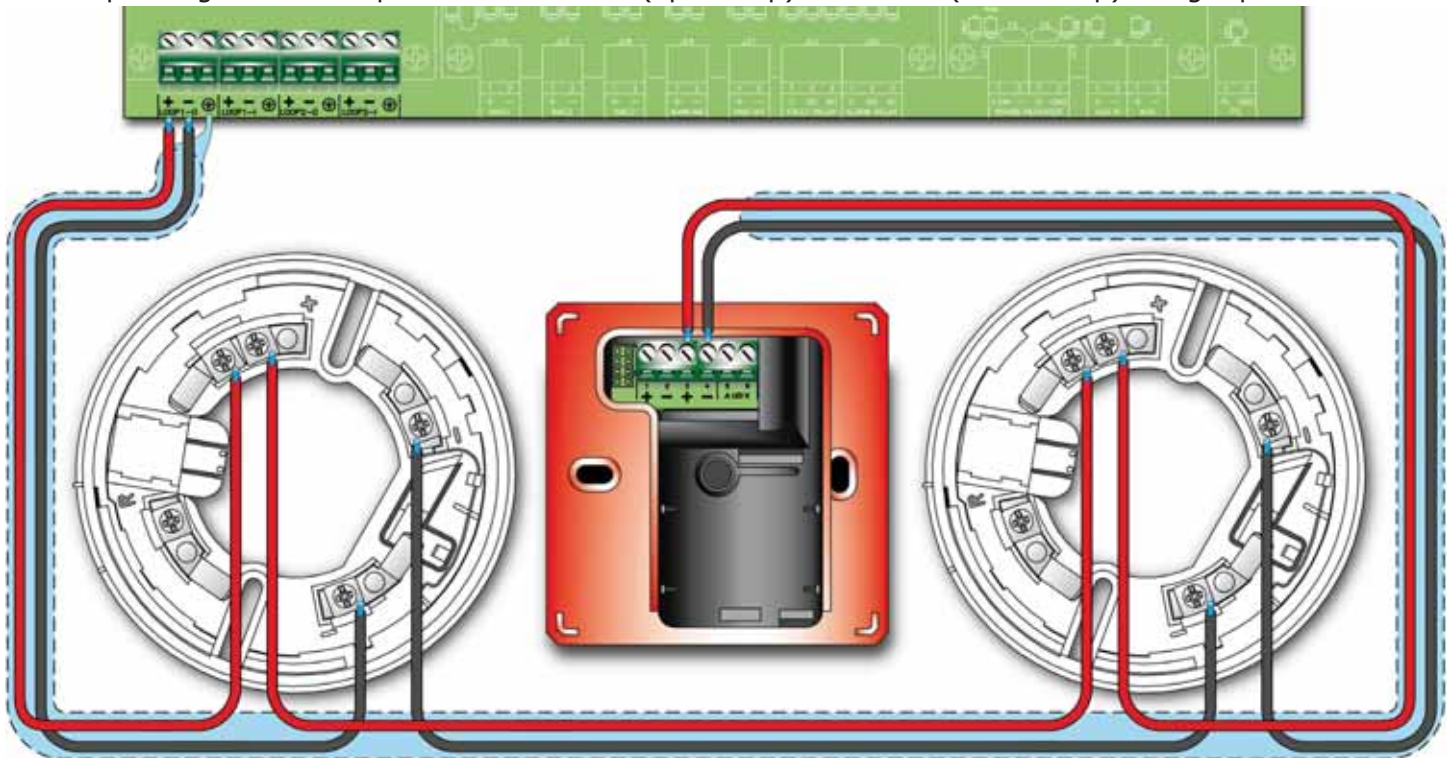

Figure 19 - 2 wire connection

If you are using a 4 wire connection, connect the STP cable shield to one end of the loop and leave the other end disconnected.

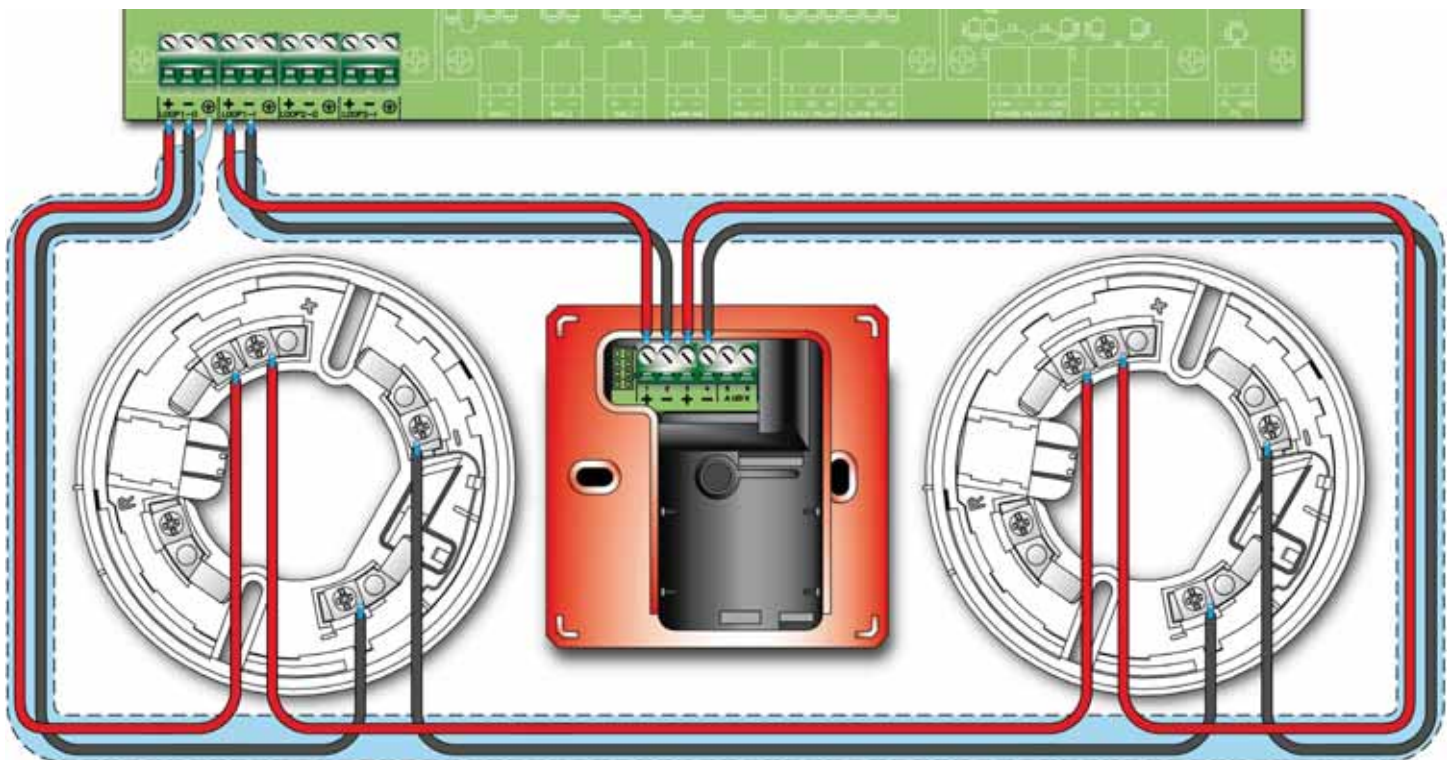

Figure 20 - 4 wire connection

7.4 NAC outputs (Notification Application Circuit)

7.4.1 Alarm NAC

The **ALARM NAC** (*paragraph 4.2 - [Z]*) is a fuse-protected, supervised-silenceable output which is to be connected to the alarm signalling devices.

This output will activate when FIRE ALARM conditions are detected. In the event of activation, the output will supply a 24V current in accordance with the polarity indicated on the terminals.

During the standby phase, a low supervisory current with reverse polarity (with respect to the silk-screened indications on the motherboard) circulates on the line. The diodes (connected in series to the loads) will direct the current to the EOL resistor which must be connected in parallel to the last device (refer to *Figure 21 - Wiring diagram of the ALARM NAC, FAULT OUT, NAC1, NAC2 and NAC3 outputs*).

7.4.2 Fault output

The **FAULT OUT** (*paragraph 4.2 - [Y]*) is a fuse-protected, supervised-silenceable output which is to be connected to the fault signalling devices (LEDS, etc.).

This output will activate when fault conditions are detected. In the event of activation, the output will supply a 24V current in accordance with the polarity indicated on the terminals.

During the standby phase, a low supervisory current with reverse polarity (with respect to the silk-screened indications on the motherboard) circulates on the line. The diodes (connected in series to the loads) will direct the current to the EOL resistor which must be connected in parallel to the last device (refer to *Figure 21 - Wiring diagram of the ALARM NAC, FAULT OUT, NAC1, NAC2 and NAC3 outputs*).

7.4.3 NAC1, NAC2 and NAC3 outputs

The **NAC1**, **NAC2** and **NAC3** outputs (*paragraph 4.2 - [A1]*) are programmable generic outputs, protected by a 1A fuse. They can be connected to various types of signaling and control devices (pressure valves, fire doors, etc.).

These outputs will activate in accordance with programming. In the event of activation, the output will supply a 24V current in accordance with the polarity indicated on the terminals.

During the standby phase, a low supervisory current with reverse polarity (with respect to the silk-screened indications on the motherboard) circulates on the line. The diodes (connected in series to the loads) will direct the current to the EOL resistor which must be connected in parallel to the last device (refer to *Figure 21 - Wiring diagram of the ALARM NAC, FAULT OUT, NAC1, NAC2 and NAC3 outputs*).

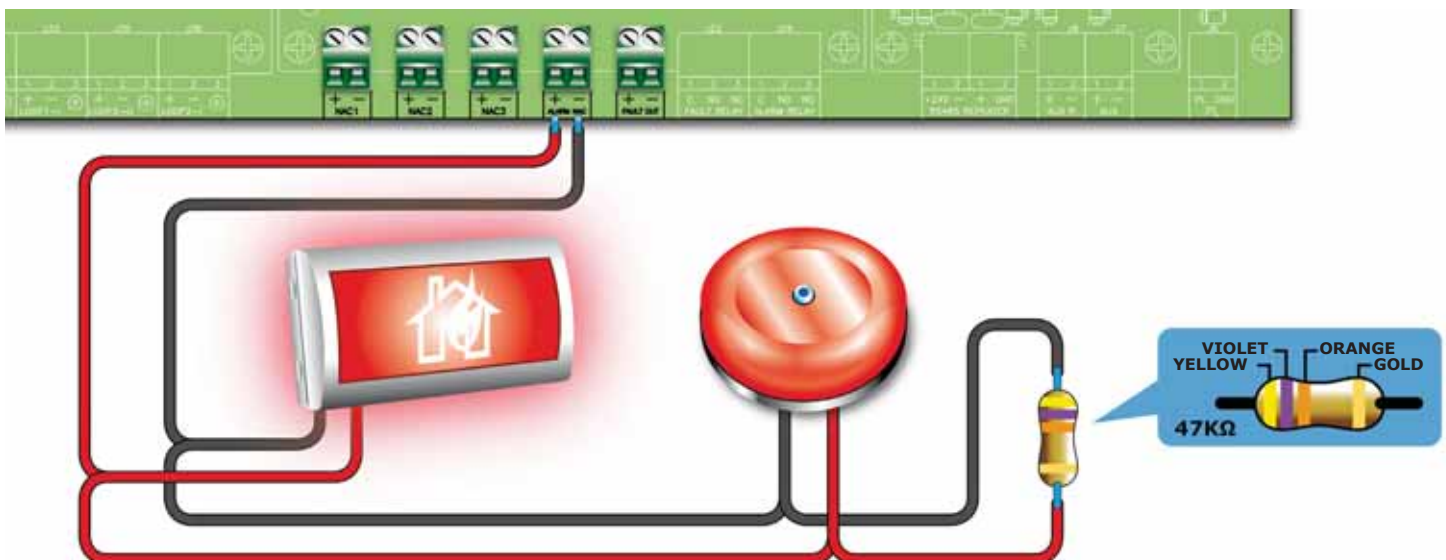

Figure 21 - Wiring diagram of the ALARM NAC, FAULT OUT, NAC1, NAC2 and NAC3 outputs

7.5 PL Terminal

These terminals can be used to provide "Shutdown" signaling.

The Normally Open **PL** terminal (*paragraph 4.2 - [S]*) closes to **GND** (ground) in the event of control panel shutdown (mains and battery power failure).l

7.6 AUX output

The **AUX** output (*paragraph 4.2 - [T]*) supplies a 24V (max 1.3A) current for external loads (ancillary devices).

This output is short-circuit protected by a resettable fuse. In the event of a short-circuit, the panel will signal an AUX output fault.

7.7 AUX-R output

The **AUX-R** output (*paragraph 4.2 - [U]*) supplies a 24V (max. 1.3A) power supply (which is removed temporarily during control panel reset) to external loads (ancillary devices) that must switch off in order to reset (e.g. beam detectors).

This output is short-circuit protected by a resettable fuse. In the event of short-circuit, the panel will signal an AUX-R output fault.

7.8 Relay output

Note: *The relay contacts on the electronic are suitable for SELV circuitry only.*

7.8.1 Alarm relay

The **ALARM RELAY** provides (*paragraph 4.2 - [W]*) a voltage-free contact which can switch loads of up to 5A (max. 30V). This relay toggles its status in the event of panel fault.

Attention: **In order to validate the IMQ-SISTEMI DI SICUREZZA certification, this output should not be used as a type C and/or E and/or J and/or G output (EN 54-1), therefore, it must not be used to command fire alarm devices and/or fire alarm transmission devices.**

7.8.2 Fault relay

The **FAULT RELAY** provides (*paragraph 4.2 - [X]*) a voltage-free contact which can switch loads of up to 5A (max. 30 V). This relay toggles its status in the event of panel fault.

Attention: **In order to validate the IMQ-SISTEMI DI SICUREZZA certification, this output should not be used as a type J output (EN 54-1), therefore, it must not be used to command Fault transmission devices.**

7.9 Connecting devices to the RS485 BUS

The RS485 BUS accepts up to 14 repeater panels, 4 power stations and 4 SmartLine-EXT conventional extinction stations.

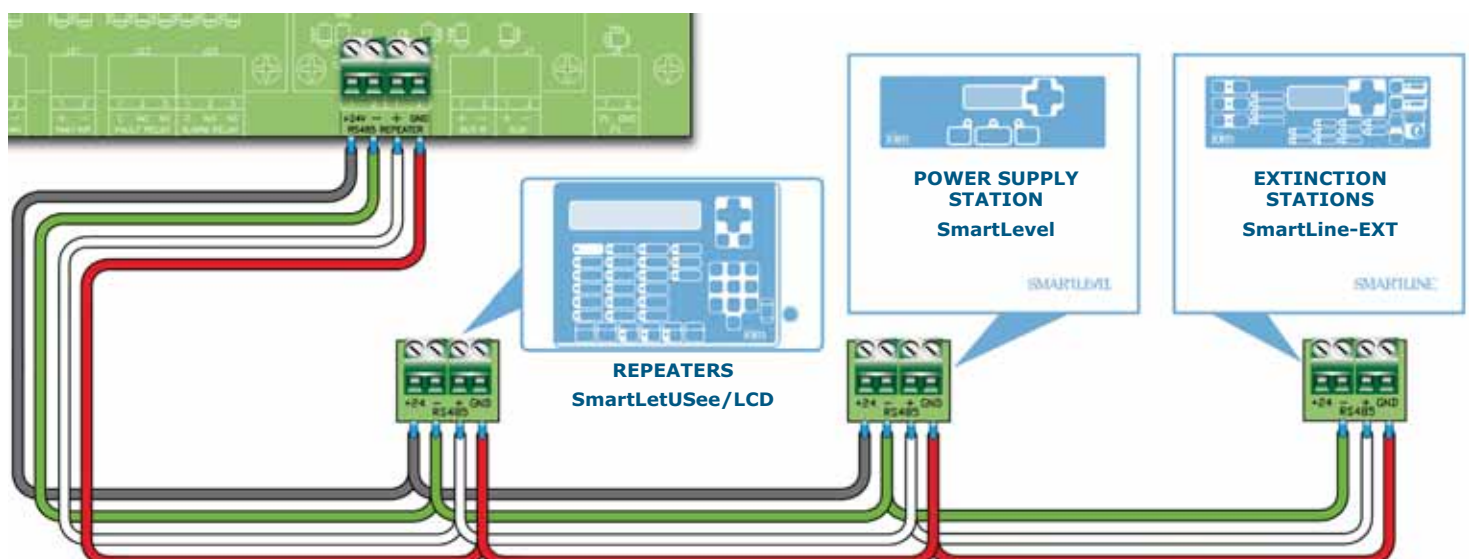

Figure 22 - Connecting the power supply station to an RS485 BUS

1. Use 4-pole shielded twisted cable for all connections.
2. Complete the RS485 BUS connections in parallel. Do not connect any wires to "+24" terminal of the RS485 BUS of the SmartLine-EXT extinction stations.
3. Insert the jumper in the EOL position on the last device, whether it is a repeater or power station (this operation must not be carried out on extinction panels).

The maximum wire length of the RS485 BUS is 1000 meters.

7.9.1 Setting the addresses of devices connected to the RS485 BUS

1. Each of the devices connected to the RS485 BUS must have a distinct address. When assigning addresses to repeaters, use the DIP switch (*paragraph 5.3 - [C]*). For the description of the addressing procedure of SmartLevel and SmartLine-EXT stations, refer to the respective programming manuals.

Address	1	2	3	4	5	6	7
DIP Switch position							
Address	8	9	10	11	12	13	14
DIP Switch position							

Attention: All other DIP switch configurations are NOT allowed.

2. Ensure that the EOL jumper (*paragraph 5.3 - [E]*) is in the EOL position (End Of Line) on the last repeater or power station on the line but not on other devices.

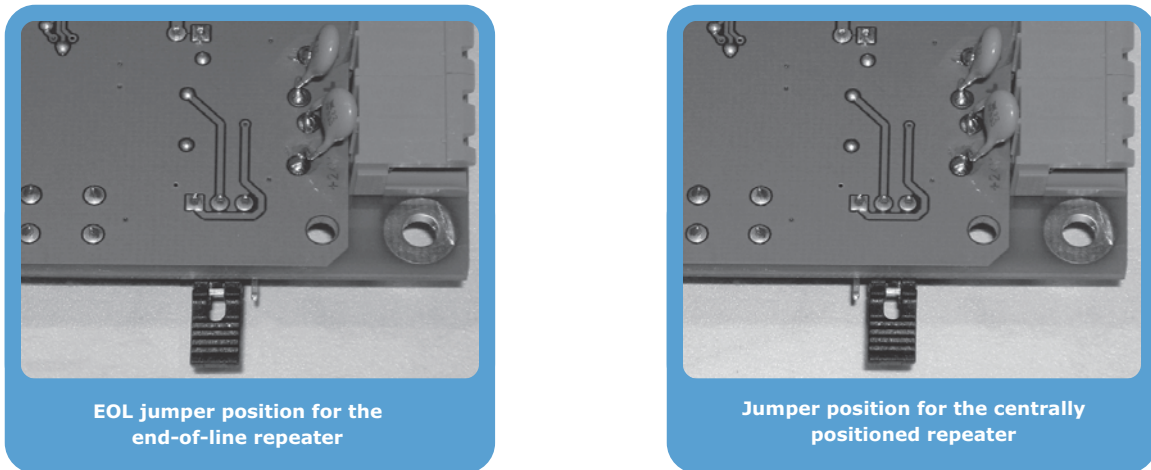

Figure 23 - SmartLetUSee/LCD-Lite board - jumper position

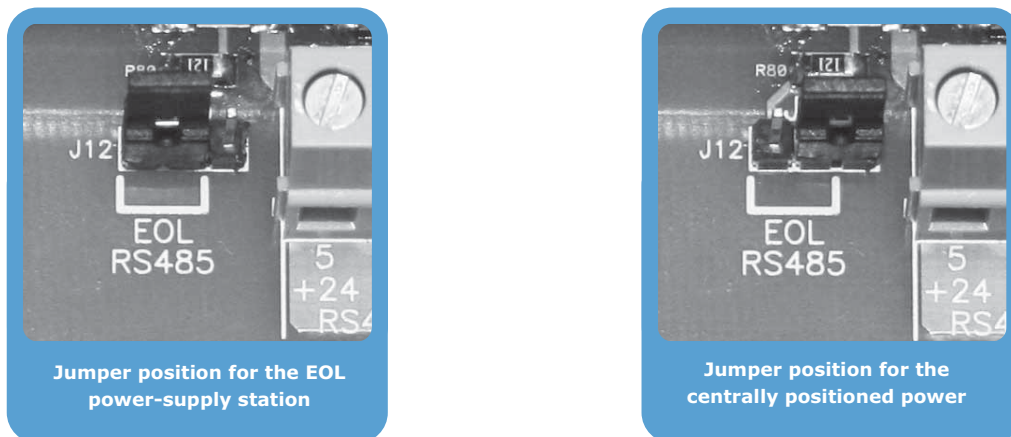

Figure 24 - SmartLevel board - jumper position

7.10 Connecting the SmartLoop/NET module

Use either 4-pole shielded twisted cable for the connections or Cat 5 STP cable for Ethernet connections. The latter will allow you to wire the data communication ring and the emergency alarm ring.

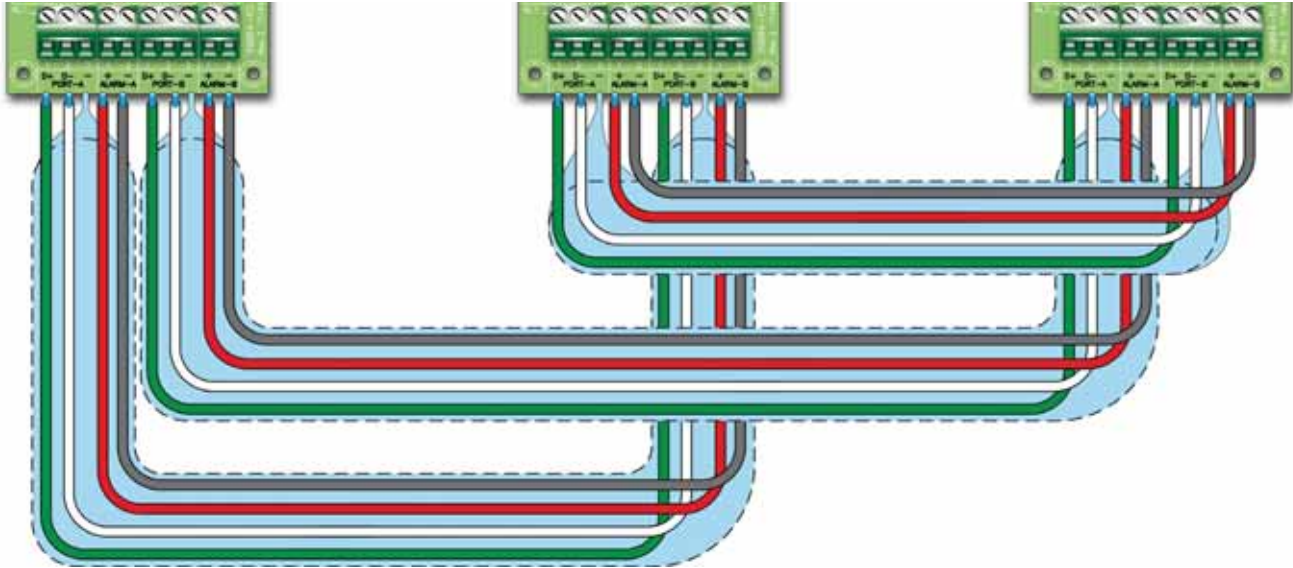

Figure 25 - Connecting the SmartLoop/NET module

Danger: In order to allow the ring to operate properly, the PORT-B and ALARM-B terminals must be connected to the successive PORT-A and ALARM-A terminals.

The control panel uses an RS485 BUS for the HorNet ring node-to-node communications. The RS485 BUS communicates at speeds of up to 57600 baud over distances up to 2000 metres between two nodes. The SmartLoop/NET ports are opto-isolated, as without isolation the connection to the data acquisition hardware to the target carries the potential for creating ground loops which will cause excessive noise in the signal.

7.11 Connecting the SmartLoop/INOUT Board

Each of the terminals on the SmartLoop/INOUT board can be configured in one of the following ways:

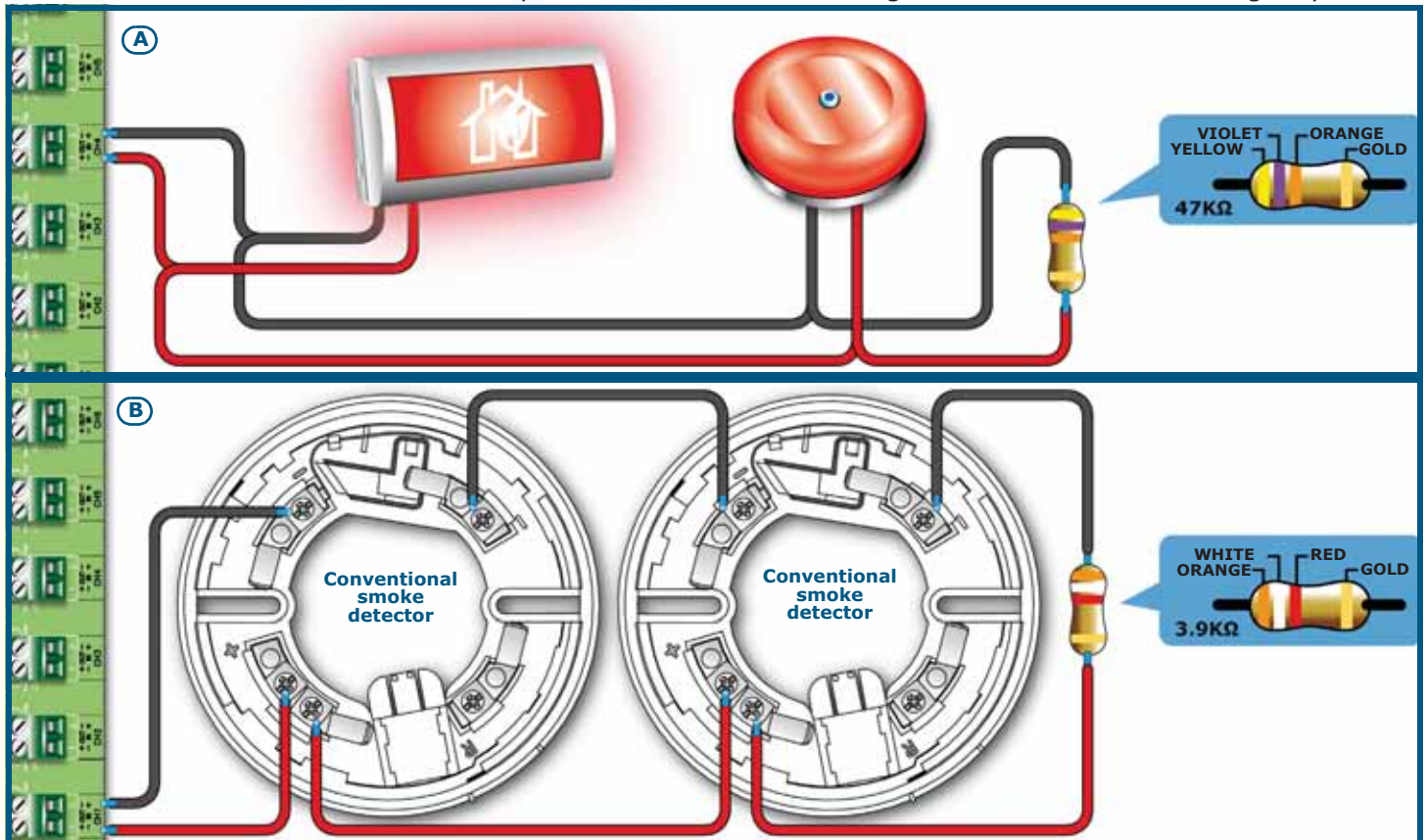

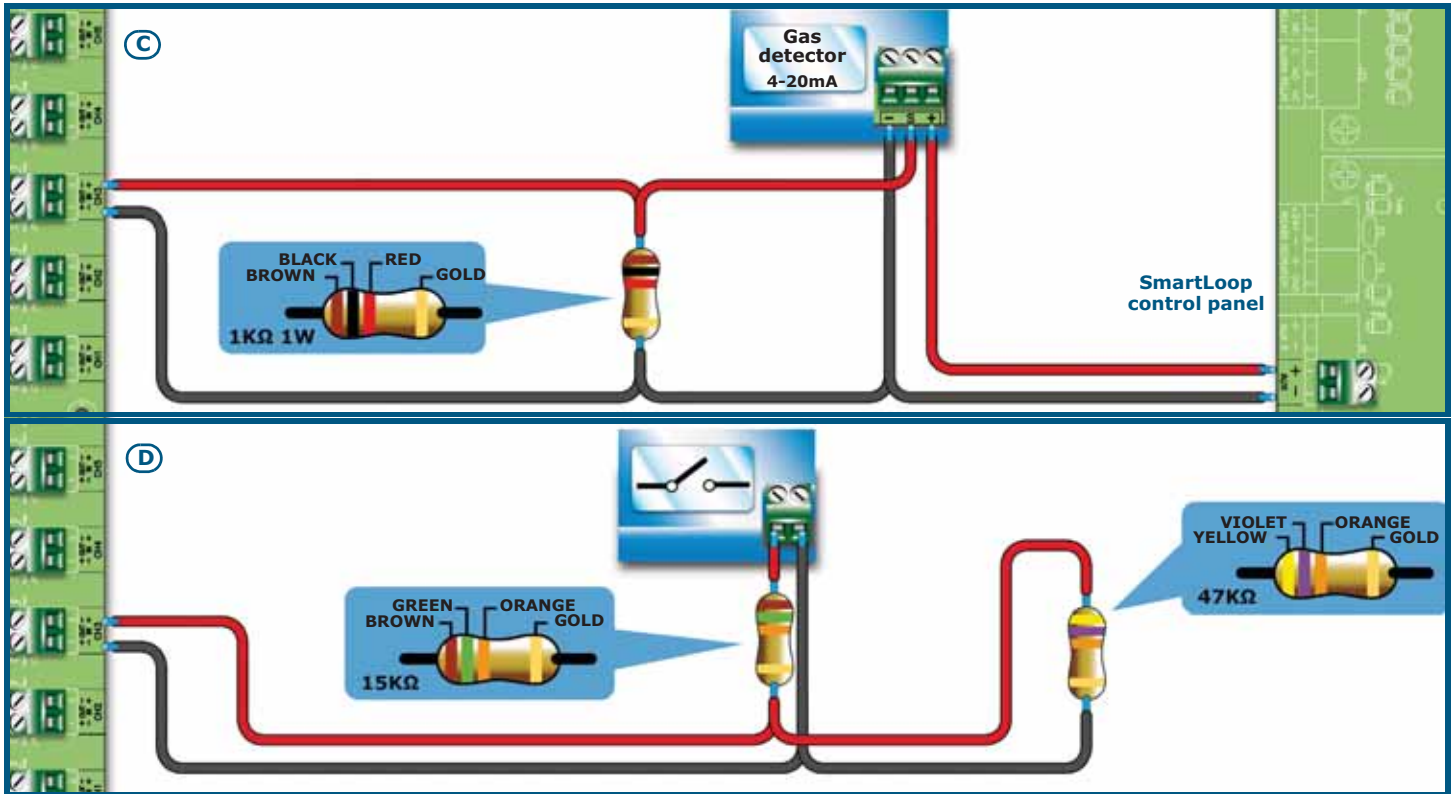

Figure 26 - Connecting the SmartLoop/INOUT module

[A]	Supervised NAC Output	
[B]	Conventional Zone	
[C]	Gas Zone	Lines configured as Gas Zone 4-20mA will generate an “early warning” signal if the value of the detector output exceeds 12mA, and an “alarm” signal if the value of the detector output exceeds 16mA. During the programming phase it is necessary to enable activation of the early-warning signal on both the control panel and the zone the line belongs to. The early warning signal will stop automatically, if the gas detector exceeds the 12mA threshold then returns below this value without reaching the zone alarm threshold.
[D]	Supervised Input	

7.12 Connecting to a PC

The panel can be connected:

- permanently to a PC equipped with monitoring software;
- temporarily to a PC during system configuration sessions (for uploading/downloading).

The panel can be connected via:

- RS232 port
- USB port
- Ethernet port (if the system is equipped with a SmartLinkLAN board)

Note: *Use of one of these ports automatically excludes use of the others.
The communication ports are opto-isolated in order to allow permanent connection to a PC or printer.*

If the connection is through the USB port, the system may ask for the installation driver when the USB cable (LINKUSBAB accessory item) is first inserted. The driver is included in the SmartLeague software program which, once installed, can be found in the following folder:

C:\Program files\Inim\SmartLeague\Drivers\

7.13 Connecting a SmartLAN (or SmartLAN/SF) equipped control panel to a PC

In this case, the RS232 and USB port will not be available for use. Therefore, the PC must be connected directly to the Ethernet port of the SmartLAN board or through a network switch by means of an inverted patch-cord.

The default IP address is 192.168.1.92

Consequently the integrated Ethernet board of the PC must be configured with an IP of the same class (e.g. 192.168.1.46). Once the configuration phase is complete, you will be able to open your browser and enter the SmartLAN board address:

http://192.168.1.92

7.14 Connecting a serial printer

1. Connect the serial printer to the RS232 port.
2. From the panel, access the main menu and select **Printer Settings**
3. Enable the printer to communicate with the panel

Note:

If you intend disconnecting the serial printer from the RS232 port in order to connect a PC, it will be necessary to DISABLE the serial printer before doing so. If you do not DISABLE the serial printer, the PC will be unable to communicate with the panel.

7.15 Batteries

The panel enclosure provides housing for two 12V/17Ah internal batteries.

Use YUASA batteries, model NP 17 -12 FR or similar with UL94-V2 flame class (or higher).

Once powered up, the panel will recharge and monitor the batteries automatically, as follows.

7.15.1 Efficiency testing

The control panel tests the battery efficiency every 10 minutes. If their internal resistance is over the allowed limit, the event will be indicated on the respective fault LED on the frontplate and on the display.

7.15.2 Voltage testing

The panel continuously monitors the battery voltage. If the voltage drops below the 22.8V, the panel will signal the event on the respective fault LED and on the display. The event will end when the voltage restores to over 24.6V.

7.15.3 Deep discharge monitoring

If the battery voltage drops below 18V, the panel will disconnect them in order to avoid battery damage. If this occurs, the PL terminal will close to ground thus generating a "Shutdown" signal.

7.15.4 Connecting the batteries

1. Locate the batteries inside the panel enclosure.
2. Using the battery wire (*Figure 27 - [A]*), connect the batteries together.
3. Connect the wire with the eyelet terminals (included) to the terminals of the batteries (*Figure 27 - [B]*).

Attention: **Ensure that connector polarity is correct.**

4. Connect the battery wire connector (*Figure 27 - [C]*) to the connector of the power supply module (*paragraph 4.4 - [C]*).

Attention: **Be sure that connector polarity is correct.**

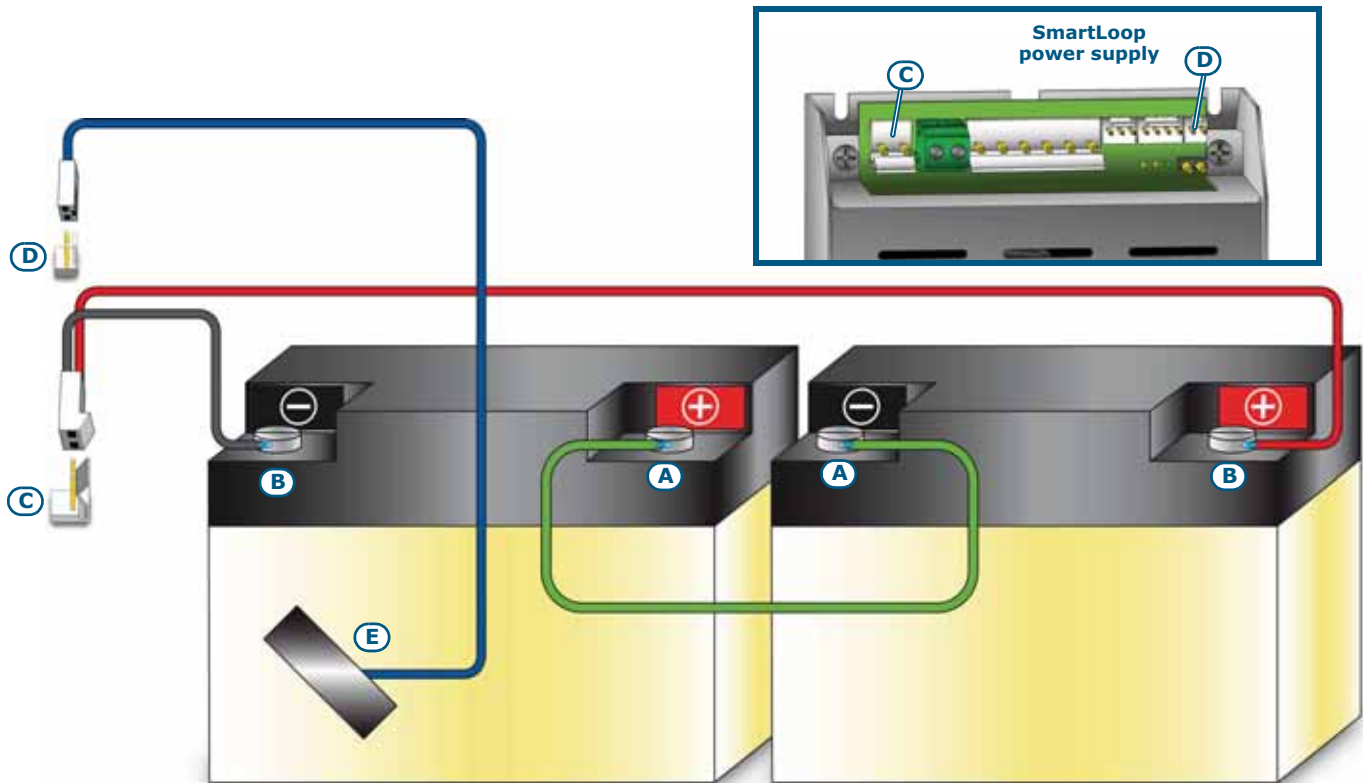

Figure 27 - Connecting the batteries

7.16 Connecting the thermal probe

Attention: In order to validate the IMQ-SISTEMI DI SICUREZZA certification and comply with EN 54-4 standard requirements, installation of a thermal probe is essential.

The power supply module is equipped with a connector (*paragraph 4.4 - [D]*) for a ProbeTH thermal probe (accessory item).

The ProbeTH thermal probe regulates the battery-charge system by interacting with the battery temperature, this operating method avoids battery damage.

Using a strip of strongly-adhesive insulating tape (*Figure 27 - [E]*), attach the Thermal probe to one of the batteries, in such a way as to provide optimized heat-transfer measurements.

7.17 Connecting the mains power source

The power system of the SmartLoop control panel is EN54-4 compliant.

Danger: DO NOT power up the system with a non-compliant voltage.

1. Connect the mains power supply to the terminals on the power-supply module (*paragraph 4.4 - [A]* and *Figure 28 - Earthing system, [A]*).

For a safety standards compliant system, the Line must be connected to terminal "L", the Neutral conductor to terminal "N".

This panel must be connected to a separate line on the Electrical Switchboard (Mains power supply). The line must be protected by a sectioning device which complies with local safety regulations, fire codes, laws and bylaws in force.

Note: As a further safety measure, the electrical system of the building must be protected against overload and short-circuit.

Note: The ends of wires must not be soft soldered in points where they are subject to clamping.

- Primary power source: 230V \sim (-15%/+ 10%) 50/60Hz.
- Maximum current draw: 1.1A

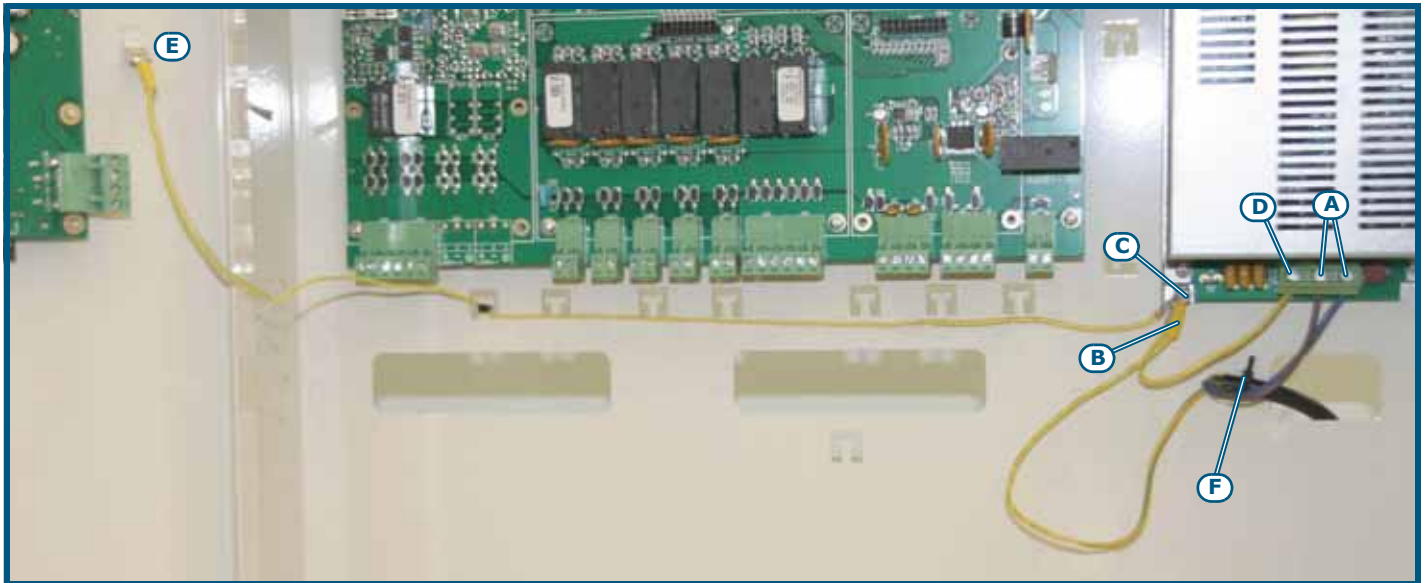

Figure 28 - Earthing system

2. Crimp the earth line wire to the eyelet terminal [B] (included in the package).
3. Attach the wire with the eyelet to the control panel using the ground connection screw [C].
4. Ensure that the terminal "⊕" of the power supply module [D] and the frontplate [E] of the enclosure are connected to earthing system.

Danger: **The protective earthing system must be compliant with the local safety regulations, fire codes, laws and bylaws in force.**

Note: *A protective earth connection ensures that all exposed conductive surfaces are at the same electrical potential as the earth surface, in order to avoid the risk of electrical shock if a person touches a device in which an insulation fault has occurred. In the event of an insulation fault, a protective earth connection will generate a high fault current which in turn will trigger an overcurrent protection device (fuse) and disconnect the power supply.*

5. Ensure that low-current safety or signal lines DO NOT come into contact with points with potentially dangerous currents.
Using a plastic cable tie, bunch the wires together and secure them to one of the wire hooks on the backplate of the enclosure [F].

Note: *The connection wires (to the mains supply and also any other wires inside the SmartLoop enclosure) must be secured to the cable hooks on the backplate by means of plastic cable ties. Use cable with double isolation for the connection to the electrical mains.*

If you are installing a SmartLoop/PSTN module, the metal spacers must be properly screwed and tightened in place as indicated in this manual.

6. Insert the two 12V/17Ah batteries and connect them to the power supply module (paragraph 4.4 - [C]).

Chapter 8

Powering up the system

Attention: **When you think you have the system completely wired, double check the integrity of the wiring and ensure that the earth connection has been completed properly before powering up.**

8.1 Testing wiring integrity

Work carefully through the following steps, use a multimeter or similar tool for the electrical measurements.

1. Using a multimeter, measure the resistance between each wire and the earth terminal in order to verify that they are properly isolated.
For accurate measurement, remove the extractable terminal boards from the motherboard.
2. Check there is no electric current flow between the cable shields and earthing system.
For accurate measurement, disconnect the shields from the respective terminals by removing the extractable terminal boards.
3. Check the wiring integrity of each NAC output.
For accurate measurements, remove the respective extractable terminal boards from the motherboard and measure the cable resistance. Test both polarities, at least one of them must have the same resistance as the EOL resistance.
4. Check all cables are adequately separated, bunched (by means of cable ties) and attached firmly to the cable hooks on the back of the enclosure.
5. Check the proper polarity of the primary power supply connections (230V~) and ensure the wires are attached firmly (by means of a cable tie) to the cable hooks on the backplate of the enclosure.
6. Ensure that the connected repeater panel DIP microswitches have been properly set (refer to *paragraph 7.9.1 Setting the addresses of devices connected to the RS485 BUS*).
7. Ensure that the EOL jumper [figure 42] is in the EOL position on the last repeater panel only.
8. If several panels are connected in a token ring network, check the integrity of the ring, as follows:
9. remove the extractable terminal boards from the connection terminals on the network board (refer to *paragraph 5.1.2 The SmartLoop/NET board*) of one of the panels and check the continuity of wiring in the D+ circuit (between the D+ poles of ports A and B), and in the D- circuit (between the D- poles of ports A and B).

8.2 First power up

1. Insert the jumper for programming-data storage (*paragraph 4.2 - [G]*); data storage is guaranteed by the 2032 lithium battery.
2. Connect the two 17Ah batteries as described in *paragraph 7.15.4 Connecting the batteries*.
3. The panel will take several seconds to stabilize and the screen will show "Resetting".
4. The "CPU FAULT" LED on the frontplate will blink to indicate board activation.
5. If the connection with mains power supply is not detected within 2 minutes, the control panel will signal a fault. Power the panel from the mains.
6. If at this point the panel signals other faults, check the wiring integrity and clear all faults before continuing (refer to *Chapter 10 - Troubleshooting*).

7. Once all fault conditions have been cleared, turn the key in the keyswitch to access Level 2 (refer to *paragraph 2.3 Operator classification - Access Levels*) then press RESET. The display will show:

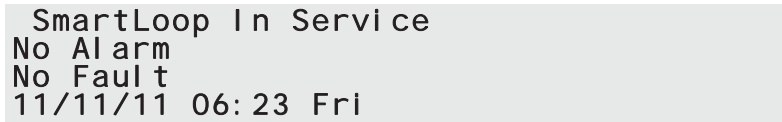

```
SmartLoop In Service  
No Alarm  
No Fault  
11/11/11 06:23 Fri
```

Figure 29 - Message on display on first startup

8. Press the TEST button to check the integrity of the LEDs.

Maintenance

The following operations must be carried out regularly.

1. Using a damp lint-free cloth, remove any dust that may have gathered on the control panel enclosure.

Attention: **Do not use any kind of cleaning product or solvent!**

2. Push the **TEST** button to check the proper operating capability of the LEDs and buzzer.
3. Check the battery efficiency and change them if necessary.
4. Check the integrity of all wires and connections.
5. Ensure that there are no insects inside the control panel.
6. Carry out maintenance on the detectors (clean the outside and the detection chamber).

Note: *Points 1 and 2 can be carried out by the users, however, all other points must be carried out by qualified technicians only.*

Troubleshooting

10.1 Fault NAC, alarm or fault output trouble

Using a multimeter or similar tool, check the voltage on the terminals. During normal operating conditions (standby status), the measurement should be around 15V with reverse polarity with regard the silk-screened indications on the terminal board.

- If the measurement is around 24V with reverse polarity with regard the silk-screened indications on the terminal board, then either the circuit does not end on the EOL resistance or there is an interruption on the cable.

Check the integrity of the device connections and the EOL resistance on the last device.

Check the cable continuity.

- If the measurement is around 0V the cable is shorted.
Check the device connections and the various cable sections.

10.2 LOOP fault

- If the "Shorted Loop OUT" warning appears on the panel display, a short-circuit in the loop across the Loop-O terminals and the first isolator has been detected.

Check the connection wiring and the integrity of the cable in the first section of the loop.

- If the "Shorted Loop-I" warning appears on the panel display (for loops with 4-wire circuitry only), a short-circuit in the loop has been detected in the section across the Loop-I terminals and their nearest isolator.

Check the integrity of the connection wiring and the integrity of the cable in the last section of the loop.

- If the "Shorted OPEN" warning appears on the panel display (for loops with 4-wire circuitry only), the Loop continuity across the Loop-O and Loop-I terminals is interrupted. This may be caused by:
 - An open isolator in the loop
Check all the isolators in the loop. At least one of the isolator LEDs will signal "Isolated" status. Once you have traced the isolator in question, check the successive isolator on the loop which, very probably, will also be open.
Check the integrity of the wiring in the section between the two isolators.
 - Cable Interruption
Disconnect the Loop-I terminals of the panel.
Check the condition of the loop-device LEDs (blinking) until you find the point where the loop is interrupted.
Once the last device in proper working order has been identified, check the integrity of the wiring downstream of the device.
 - Missing loop devices (the panel is unable to find some of the connected loop devices)
Search the loop for the missing devices. Once the missing devices have been identified, check the integrity of the wiring and the address of each missing device.
 - Duplicated address (an address has been assigned to more than one device)
Switch On the LED of the devices that signal duplicated address.
Search the loop for the devices concerned. Once the devices have been identified, check the address of each device and rectify the error.
- Loop status LEDs
 - Check that the blinking Loop transmission LED (red) corresponds to the respective loop settings. If the LED does not correspond, check the loop parameters.
 - The green LED of each loop will blink each time an interrogated device responds. If this LED is On solid, it means the device response is masked by an anomalous current flow through the conductive path between the two poles of the loop.

Attention: **Ensure that only the system devices are connected to the loop.**

Following is a table listing the faults signalled by the control panel relating to the connected loop devices:

The panel shows the message:	Meaning
Mi ssi ng	The control panel is unable to communicate with the device. Possible cause: connection fault, device removed or in fault status.
Open i nput	The EOL resistance cannot be read. Possible cause: interrupted cable, resistance not connected, fault on the device connected to the input.
Short i nput	Short-circuit condition on the device input terminals. Possible cause: short-circuited wiring, inadequate resistance.
Open output	The EOL resistance cannot be read. Possible cause: interrupted cable, resistance not connected.
Short output	Short-circuit condition detected on the device output terminals. Possible cause: short-circuited wiring, inadequate resistance.
Power faul t	The 24V on the module input cannot be detected. Possible cause: interrupted cable, 24V line not connected, inadequate current.
Loop short	The device isolator is open. Possible cause: short-circuit on the loop, inadequate loop current.

10.3 Fault on devices connected to the RS485 BUS

If the display shows "Repeater Lost", "Power Stat. Lost", "Ext. Stat. Lost" , the panel is unable to find any devices connected to the BUS.

- Check that the device addresses have been assigned correctly (refer to *paragraph 7.9.1 Setting the addresses of devices connected to the RS485 BUS*).
- Check the integrity of the wiring and the connection polarity.
- Check that the EOL jumper is in the EOL position only on the last repeater or power station connected to the BUS.
- Using a multimeter or similar tool for the electrical measurements:
 - Measure the voltage across the +24 V and GND terminals of the RS485 BUS. If the voltage is below 20V, the resettable protection fuse is open, therefore, the current draw of the devices connected to the BUS is excessive.
 - Disconnect the devices connected to the BUS one at a time until you find the cause.

10.4 Battery Fault

If the "Battery Lost" message is shown, the batteries are either disconnected or have failed the battery efficiently test.

Allow them to recharge for several hours. If the trouble persists, disconnect the batteries from the panel and, using a multimeter or similar tool, measure them separately.

- If only one of the batteries is below 12.5V: replace the battery concerned and allow it to recharge for several hours until fully charged.
- If both batteries are below 12.5 V - 13 V: replace both batteries and allow them to recharge for several hours until fully charged.
- If the battery is equipped with a thermal probe, check that the voltage value corresponds to the value calculated with the assistance of the graph (*paragraph 7.15.4 Connecting the batteries*). If there is a discrepancy in the current value, correct it by means of the trimmer on the power supply module.

If the "Low Battery" message is shown, the switching power supply (230V~ mains supply) will shutdown. This condition must be cleared before the batteries get too low and are unable to power to the system.

10.5 SmartLoopNET Fault

10.5.1 Error in the token ring network configuration

Access to Network Denied
Network board NOT found
or address already occupied or Loop Open

Figure 30 - Access Denied message

This message appears when:

- The SmartLoop/NET board is not operating properly.
Check that the board is inserted properly.
Relaunch the auto-configuration phase.
Ensure that the blue LED (*paragraph 5.1 - [E]*) remains On during this phase, and that the activity LEDs of nodes A and B (*paragraph 5.1 - [F]* and *paragraph 5.1 - [G]*) flicker briefly to indicate communication attempts on both sections.
If all the LEDs are Off, the board may be damaged and it may be necessary to replace it.
- An address has been duplicated, that is, assigned to more than one panel.
Access the main menu from the panel. Select **Programming, Configuration, View, Network**.
Check the address of each panel in the token-ring network and rectify the error.
- Network circuit open
The token-ring network cabling must be closed properly otherwise the system will be unable to configure properly.
Check the integrity of the ring cabling, as follows:
 - Restore all the panels in the token-ring network to address 0.
 - Disconnect the network terminals of the SmartLoop/NET board of one of the panels, then check the continuity of the wiring between the "D+" poles of the A and B ports and between the "D-" poles of the A and B ports and the two "-" poles (refer to *paragraph 5.1.2 The SmartLoop/NET board*).

10.5.2 Fault on ALARM-A/B terminals

Wiring fault in the emergency alarm ring circuit.

- Check the integrity of the circuit wiring of the panel that generated the event.
Using a multimeter or similar tool, measure the voltage over terminals ALARM-A "+" and "-". Under normal operating conditions the value should be approximately 2.5V.
 - If the value is nearer to 5V, the connection with terminals ALARM-B "+" and "-" of the adjacent control panel is interrupted.
 - If the voltage is nearer to 0V, there may be a short-circuit between the two poles that connect the ALARM-A "+" and "-" terminals of the board concerned with the ALARM-B "+" and "-" terminals of the antecedent board.
- Check the integrity of the connection.

Note: *If the emergency alarm loop is not used, it must be disabled via software, otherwise it will signal a persistent fault condition.*

10.6 Other faults

The panel shows the message:	Meaning
AUX output fault	A short-circuit has occurred on the AUX terminals, the protective resettable fuse has blown.
AUX-R output fault	A short-circuit has occurred on the AUX-R terminals, the protective resettable fuse has blown.
Mains fault	Primary power failure (230V~).
Earth fault	Voltage dispersion to earth has been detected. This fault signal can be disabled by disconnecting the respective jumper (<i>paragraph 4.2 - [L]</i>).
Maintenance request	The preset date for Maintenance has expired.

Appendix A

Enea series devices



All Enea series devices manufactured by INIM Electronics for addressable-analogue detection are LPCB certified and carry the CE mark in compliance with the CPD standard.

Each device is equipped with a short-circuit isolator which, in the event of short-circuit between two control-panel (loop) connection wires, is capable of interrupting the negative wire and isolating the wire section concerned. The loop supports up to 240 devices. Each device is identified by a factory-assigned serial number which allows automatic addressing.

INIM Electronics provides three Enea series analogue-detector models:

- Optical chamber with sealed upper-part and 500 micron hole-diameter mesh insect screen
- Tricolour LED - red for alarm, green flash for standby and for identification at the control panel; yellow for fault status
- Supervised remote output configurable from the control panel
- Automatic recognition of remote signaller connection
- Drift compensation for sensor drift caused by dust in the chamber
- Sensitivity selection for smoke and heat thresholds
- Operating mode selection (for ED300 version) - Only smoke; Only heat
- AND mode, OR mode, PLUS mode
- Complete diagnostics - provides contamination level and real-time values
- Memory of the smoke and temperature levels measured in the five-minute period prior to the last alarm detected
- Bypass plate on base guarantees line continuity in the event of removal of the detector

For further details regarding the precise features and technical specification of each device, refer to the respective instructions booklet.

Type	Model	Description
Detectors	ED100	Optic smoke detector
	ED200	Heat detector
	ED300	Smoke and heat detector
Bases	EB0010	Mounting base
	EB0020	Relay base
	ESB010	Sounder base (to be installed under EB0010 mounting base)
	ESB020	Sounder base and beacon (to be installed under EB0010 mounting base)
Modules	EM312SR	Input and Output module
	EM110	Input module
	EM311	Micromodule
	EM344S	4 input + 4 output conventional zone interface
Manual call points	EC0010	Manual call point
	EC0010E	Manual call point for outdoor installation (IP67)
Alarm repeater	FI100	Remote addressable alarm repeater

Sounders	ES0010RE	Addressable loop-powered sounder unit in red enclosure
	ES0020RE	Addressable loop-powered sounder&beacon unit in red enclosure
	ES0010BE	Addressable loop-powered sounder unit in white enclosure
	ES0020BE	Addressable loop-powered sounder&beacon unit in white enclosure
	ES0020	Loop-powered addressable warning sign
Driver	EITK1000	Kit for the configuration, maintenance and diagnostics of systems using IRIS and ENEA series devices
	EITK-DRV	Driver for zones with IRIS series devices or loops with ENEA series devices
	EITK-BASE	Base for IRIS and ENEA series detectors
	EITK-PWSP	Power supply for the EITK-DRV driver

A.1 Configuring Enea devices

The distinct serial number of each detector is shown on the device information label. Manual addressing is unnecessary as the addressing phase is automatic. To address devices, connect them to the loop and work through the following steps.

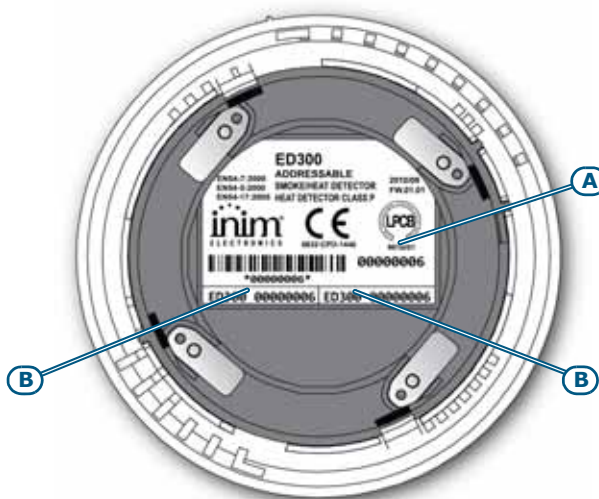

Figure 31 - The reverse side of Enea detectors

The serial number is shown on the information label [A] and on two smaller removable labels [B]. When installing the devices, it is strongly advised to remove the small labels and place one on the system layout and the other on the mounting base. This will facilitate device tracing and re-location operations.

Note: *Each loop supports up to 240 devices.*

A.1.1 Re-addressing devices

After connecting the devices to the loop, you must then configure the loop.

The addressing phase allows the system to determine the serial number of each device connected to the loop and assign a logic address (a number between 1 and 240). The system will use this number to identify the point during all the system programming operations.

From panel: <key>, **Programming**, <code>, **Configuration**, **Modify Configuration**, **Manual Configuration**, **Loop** - select the loop - **Loop parameters** - set the protocol type as **INIM** and the wiring method as **4 Wire**, **Esc, Esc, Esc, Auto Enroll, Loop**, place the cursor arrow on the desired loop (column 1 to 8) on the **RE-ADDRESS ALL**. line. Using the **▲** key, enter the **"+"** sign (which will appear on both lines automatically), **Esc, Esc**

Loop N.		1	2	3	4	5	6	7	8
ENROLL DEVICES	:	:	:	:	:	:	:	:	:
RE-ADDRESS ALL.	:	:	:	:	:	:	:	:	:

Once this operation is complete (which may take several minutes), a summary screen indicating the total number of devices found will be shown. Ensure that the number of devices found corresponds to the number of devices actually installed.

Via PC: select the loop > Parameter Tab to select the type of protocol and wiring method, select the icon  and select **Re-address loop**.

Once this operation is complete (which may take several minutes), the software program will design a layout of the loop wiring showing all the connected devices.

A.2 Reading the loop

This operation allows the system to learn the serial numbers of all the devices connected to the loop and enroll the logic addresses (number between 1 and 240) assigned to them during the addressing phase.

Note: *The loop reading phase can be carried out only on previously addressed loops, either via the control panel or by means of an EITK-DRV loop driver.*

From panel: <key>, **Programming**, <code>, **Configuration**, **Modify Configuration**, **Manual Configuration**, **Loop**, select the loop, **Loop parameters**, set the protocol type as **INIM** and the wiring method as **4 Wire**, **↵**, **Esc**, **Esc**, **Esc**, **Auto Enroll**, **Loop**, place the cursor arrow on the desired loop (column 1 to 8) on the **ENROLL DEVICES** line. Using the **▲** key, enter the "+" sign (which will appear on both lines automatically), **↵**, **↵**

Once this operation is complete, a summary screen showing the total number of devices found will be shown. Ensure that the number of devices found corresponds to the number of devices actually installed.

Via software program: select the loop > Parameter Tab to select the type of protocol and wiring method, select the icon  and select **Read loop**.

Once this operation is complete (which may take several minutes), the software program will design a layout of the loop wiring showing all the connected devices.

A.3 Updating the loop

This operation must be carried out each time a device is replaced or added to the previously configured loop. After replacing or adding devices to the loop, work through the following operations.

From the panel:

Adding/Replacing a device: <key>, **Programming**, <code>, **Configuration**, **Modify Configuration**, **Manual Configuration**, **Loop**, select the loop, **Add/Modify Point**, select the point and enter the serial number of the new or replacement device.

Removing a device: <key>, **Programming**, <code>, **Configuration**, **Modify Configuration**, **Manual Configuration**, **Loop**, select the loop, **Remove point**, select the point and press **↵** to confirm.

Via software application: select the loop from the tree structure, then select the icon  and then the **Update Loop** option.

Once this operation is complete (which may take several minutes), the software program will show a double layout which will allow you to compare the previously-saved loop configuration with the new one. The part with changes will be highlighted.

In order to continue, you must accept all the highlighted changes and double-click on any icons which are not green, or press the **Accept All** button) and press **CONTINUE**. A new addressing phase (which may take several minutes) will transfer the new configuration to the control panel.

Argus Devices

Note: *The ARGUS devices accepted by this control panel do not have IMQ-SECURITY SYSTEMS certification, refer to the instructions leaflet provided with each device.*

All Argus Vega devices have built-in loop isolators. Therefore, isolators are not required. A short-circuit on the loop will not provoke loss of any device.

Each detector is equipped with a 3-colour LED: green (periodic blinking) indicates the detector is working properly (if enabled). Yellow indicates that the detector is not operating properly (fault) or has an open isolator, whereas red indicates alarm status.

Detectors are equipped with test LEDs: if you hold a magnet near the detector base (near to the two notches) the detector should generate an alarm signal.

B.1 Devices

Model	Name	Description
V100	Analogue Photo detector	Optical Smoke detector
V200	Analogue multicriteria detector	Optical Smoke/Heat detector
V350	Analogue heat detector	Heat detector ^(a)
VCP100	Intelligent resettable call point	Resettable call point
VWCP100	Weatherproof intelligent resettable call point	Resettable call point for outdoor installation
VMI100	Input module	Module with 1 supervised input
VMMI100	Input minimodule	Mini module with 1 Supervised Input
VMDI100	DIN rail input module	DIN rail module with 1 supervised input
VUMI100	Input micromodule	Micromodule with 1 supervised input
VMC100	Output module	Module with 1 supervised output
VMMC100	Output Mini Module	Minimodule with 1 supervised output
VMDC100	DIN rail output module	DIN rail module with 1 supervised output
VUMC100	Output Micromodule	Micromodule with 1 supervised output
VMC120	Output module Form C	Module with 1 voltage-free output (non-supervised)
VMMC120	Output Mini Module Form C	Minimodule with 1 voltage free output (non-supervised)
VMDC120	DIN rail output module Form C	DIN rail module with 1 voltage free output (non-supervised)
VUMC140	Output Micro module Form C	Micromodule with 1 voltage free output (non-supervised)
VMIC100	Input/Output Module	Module with 1 supervised input + 1 supervised output
VMMIC100	Input/Output Mini Module	Minimodule with 1 supervised input + 1 supervised output
VMDIC100	DIN rail Input/Output module	DIN rail module with 1 supervised input + 1 supervised output
VMIC120	Input/Output module Form C	Module with 1 supervised input + 1 non-supervised output (voltage free contact)
VMMIC120	Input/Output Mini Module Form C	Minimodule with 1 supervised input + 1 non-supervised output (voltage free contact)
VMDIC120	DIN rail Input/Output Module Form C	DIN rail module with 1 supervised input + 1 non-supervised output (voltage free contact)

VMCZ100	Conventional line interface module	Interfaces conventional devices to the loop
VMIC404	Module with 4 inputs and 4 outputs	Module with 4 supervised inputs and 4 outputs (dry contact)
VLS100	Intelligent Wall Sounder	Loop-powered sounder
VWLS100	Weatherproof Intelligent Wall Sounder	Loop-powered sounder for outdoor installation
VLS100-AV	Intelligent Wall Sounderflasher	Loop-powered sounderflasher
VWLS100-AV	Weatherproof Intelligent Wall Sounder/Flasher	Loop-powered sounderflasher for outdoor installation
VLBE100	Intelligent Flasher	Flasher powered through the loop
VTAO10	Sounderflasher fire sign	Visual/Audible warning sign with input/output module
VTAOA10	Self-powered Sounder/Flasher fire sign	Self-powered visual/audible warning sign with input/output module
VFI100	Intelligent remote indicator	Remote addressable alarm repeater
VPU100	Programmer	Allows fast addressing of Argus series devices

- a. Configured as "Rate-of-rise detector" at default (alarm is triggered by rapid rise in temperature or when the temperature exceeds the 54°C alarm threshold). To configure as "High temperature detector" (Rate-of-rise feature bypassed and fixed temperature set at 70°C) use the VPU100 programmer. The panel will recognize the configuration criteria automatically.

B.2 Device bases

Model	Name	Description
VB100	Base	Standard base for VEGA detectors
VDBS100	Deep standard base	Allows connection to wall-mount cable runs
VBLR100	Relay base	Relay activated by the detector R output attached to the base
VBS100	Base with sounder	Activated by the R output of the detector attached to the base
VBLS100	Base with addressable sounder	Occupies a loop address

B.3 Wireless devices

Model	Name	Description
VW2W	Wireless translator	Connected to Loop, 32-device interface (Sagittarius series - SG) wireless to panel The panel reads the 32 devices as if they were physically connected to the Loop (with different addresses)
SGWE	Wireless expansion	
SG100	Wireless analogue smoke detector	
SG200	Wireless analogue Smoke/Heat detector	
SG350	Wireless heat detector	(^a)
SGRBS100	Wireless sounder base	
SGRBS100-AV	Wireless sounder base with beacon	
SGMI100	Wireless input module	
SGMC100	Wireless output module	
SGMCB100	Wireless module with 2 outputs	
SGCP100	Wireless call point	
SGRS100	Wireless sounder	
SGVA100	Wireless voice announcer	
SGFI100	Wireless addressable remote alarm repeater	

- a. Configured as "Rate-of-rise detector" at default (alarm is triggered by rapid rise in temperature or when the temperature exceeds the 54°C alarm threshold). To configure as "High temperature detector" (Rate-of-rise feature bypassed and fixed temperature set at 70°C) use the VPU100 programmer. The panel will recognize the configuration criteria automatically.

B.4 Device Consumption

Device	in standby	in alarm
Detectors	90 μ A	6 mA
Modules	120 μ A	6 mA

B.5 Configuring Argus devices

Every ARGUS device requires an address to identify it in the loop. You can address ARGUS devices by either using a VPU (Vega Programming Unit) or by means of the Auto-addressing option.

B.5.1 Auto-addressing from panel

At the SmartLoop panel keypad:

1. Press any key to access the Main menu.
2. Select **Programming, <code>, Configuration, Modify Configuration, Manual Configuration, Loop**
3. Select the Loop to be configured (1 - 8).
4. Select the loop parameters. The respective loop parameter screen will be shown:

```

Loop firmware version : 1.00
<Loop n>
Loop Type : ARGUS
Loop Wiring : 4 Wires
    
```

Figure 32 - Loop parameters

5. Program the loop in accordance with the connected device type and circuitry (2 or 4 wires).
6. Press the \leftarrow button to confirm the setting and exit the screen

Note: *If you exit the screen using the **Esc** button, the setting WILL NOT BE SAVED!*

7. Press **Esc** repeatedly until you return to the **Programming** menu.
8. Select **Configuration, Modify Configuration, Auto Configuration, Loop**

```

Loop N.          1 2 3 4 5 6 7 8
AUTO-CONFIGURATION : . . . . .
AUTO-ADDRESSING  : . . . . .
    
```

Figure 33 - Loop programming screen

9. Enter a "+" sign in the programming field that corresponds to the loop concerned.
 Use the cursor keys \blacktriangle and \blacktriangledown to select/deselect the options and cursor keys \blacktriangleleft and \blacktriangleright to move from one loop to another.
 If you select "Auto-configuration", the control panel will enroll the devices connected to the loop using the pre-assigned address (assigned by means of the VPU100) without making changes to the devices enrolled during previous operations.
 If you select the "Re-addressing" option, the previously assigned addresses will be deleted and new addresses will be given. All previously programmed data will be cleared.
10. Press \leftarrow - the panel will show the summary screen and ask for permission to continue.
11. Press \leftarrow to start the "Auto-configuration" phase.

B.5.2 Addressing detectors using the VPU100

Work carefully through the following steps:

1. Remove the detector from its base (twist off).

2. Fit the detector into the VPU100 (twist on).
3. Press any button on the VPU100 to switch On the unit.
4. Using the scroll keys, select an address (1-240) then press the "WRITE" button (top left) to confirm the selection.

Note: *Two hundred and forty addresses are available. Address entry errors can be corrected by simply readdressing the device (deletion not required).*

5. Remove the detector from the VPU100 and fit it to its placement.

B.5.3 Addressing detectors using the VPU100

Work carefully through the following steps:

1. Extract terminals 1- 4 from the module.
2. Connect the VPU cable to the module, positive to terminal 1 and negative to terminal 3.
3. Press any button on the VPU to switch On the unit.
4. Using the scroll keys, select an address (1-240) then press the "WRITE" button (top left) to confirm the selection.

Note: *240 addresses are available. Address entry errors can be corrected by simply readdressing the device (deletion not required).*

5. Disconnect the wires of the VPU100 and reconnect the module to the Loop.



Figure 34 - Addressing modules using a VPU100

Apollo devices

Note: *The APOLLO devices supported by this control panel do not have IMQ-SISTEMI DI SICUREZZA certification; refer to the instructions leaflet provided with each device.*

Apollo devices are not equipped with built-in loop isolators (unless otherwise specified). Therefore, isolators must be installed in the loop in such a way as to avoid the loss of more than 32 devices during short-circuit events.

C.1 Devices

C.1.1 Detectors: XP95 series

Note: *XP95 series detectors are especially designed to operate with a sensibility of 55 (sensibility at default). Sensibility adjustment should be made only when absolutely essential, as any change may lead to delays in loop response time.*

Model	Name	Description
55000-885	XP95 Multisensor detector	Senses for smoke and temperature changes
55000-600	XP95 Optical smoke detector	Senses for smoke particles
55000-500	XP95 Ionization smoke detector	Senses for changes in electrical conductivity across its detection chamber
55000-400	XP95 Heat detector - standard temperature	Senses for standard increase in ambient temperature
55000-401	XP95 Heat detector - high temperature	Senses for high increase in ambient temperature
55000-640	XP95 I.S. Smoke detector	Intrinsic-security smoke detector
55000-440	XP95 I.S.Heat detector	Intrinsic security heat detector
55000-540	XP95 I.S. Ionization smoke detector	Intrinsic security ionization smoke detector

C.1.2 Detectors: Discovery series

Model	Name	Description
58000-600	Discovery Optical smoke detector	Senses for smoke particles in its detection chamber
58000-400	Discovery Heat detector	Senses for increase in ambient temperature
58000-700	Discovery Multisensor detector	Senses for smoke and increase in ambient temperature
58000-300	Discovery Carbon Monoxide detector	Senses for carbon monoxide in the protected area
58000-500	Discovery Ionization smoke detector	Senses for changes in electrical conductivity across its detection chamber

C.1.3 Detectors: Xplorer series

Note: *Xplorer series detectors are especially designed to operate with a sensibility of 55 (sensibility at default). Sensibility adjustment should be made only when absolutely essential, as any change may lead to delays in loop response time.*

Model	Name	Description
59000-405	Standard heat detector with standard base	Senses for increase in temperature and mounts to standard base
59000-406	Standard heat detector with LED driver base	Senses for increase in temperature and provides remote-LED control

59000-407	Standard heat detector with sounder base	Senses for increase in temperature and mounts to sounder base
59000-415	High temperature heat detector with standard base	Senses for high temperature and mounts to standard base
59000-416	High temperature heat detector with LED driver base	Senses for high temperature and mounts to remote-LED driver base
59000-417	High temperature heat detector with sounder base	Senses for high temperature and mounts to sounder base
59000-605	Optical Smoke detector with standard base	Senses for smoke particles and mounts to standard base
59000-606	Optical smoke detector with LED driver base	Senses for smoke particles and mounts to remote-LED driver base
59000-607	Optical smoke detector with sounder base	Senses for smoke particles and mounts to sounder base

C.2 Device Bases

Model	Name	Description
45681-210	XP95/DISCOVERY Mounting base	Mounting base for XP95/DISCOVERY detectors
45681-215	XP95 I.S. Mounting Base	Intrinsic security mounting base
45681-321	XP95/DISCOVERY Isolating Base	Mounting base with isolator for XP95 detectors
45681-242	XP95/DISCOVERY Low power relay base	Mounting base with relay
45681-250	XP95/DISCOVERY E-Z fit base	Large mounting base (150mm)
45681-276	Ancillary sounder base	Base with audible signalling function

C.3 Accessories

Model	Name	Description
55000-720	XP95 Isolator	Isolator for loops
59000-700	XPlorer Isolator	Isolator for XPlorer loop
55000-855	XP95 protocol translator	Protocol translator for intrinsically safe lines

C.4 Call points

Model	Name	Description
55000-905	XP95 Manual call point - surface mount	Surface mounting manual alarm button for XP95 loop
55000-906	XP95 Manual call point	Flush mounting manual alarm button for XP95 loop
55000-940	XP95 I.S. Manual call point	Intrinsic security manual alarm button
58000-910	Discovery Manual call point - surface mount	Surface mounting manual alarm button
58000-920	Discovery Manual call point - flush mount	Flush mounting manual alarm button
59000-910	Xplorer Manual call point	Manual alarm button from the Xplorer series

C.5 Sounder + Flasher

Model	Name	Description
55000-278	Loop powered sounder	Audible-signalling device powered through the loop
55000-274	Weatherproof loop powered sounder	Audible-signalling device powered through the loop for outdoor installation
45681-265	Intelligent base Sounder	Base sounder with its own address
55000-877	Loop powered beacon	Visual signalling device powered through the loop
45681-331	Loop powered sounder + flasher	Visual and audible signalling device powered through the loop

C.6 Modules

Model	Name	Description
55000-809	XP95 Switch monitor plus	Module with 1 delayed input and reset output for waterflow detectors (waterflow alarm)
55000-810	XP95 Switch monitor	Single input module
55000-813	XP95 Zone monitor	Conventional detector interface module
55000-818	XP95 Input/Output module	Module with 1 relay output + 1 supervised input + 1 non-supervised input
55000-819	XP95 Output module	Module with 1 relay output
55000-823	XP95 Sounder control unit	Module with 1 output for control of externally-powered audible signalling device
55000-875	XP95 Mains switch input/output	Module with 1 supervised input + 1 relay x 220V
55000-832	XP95 Mini switch monitor (interrupt)	Mini input module with interrupt function
55000-833	XP95 mini switch monitor	Mini input module
59000-810	XPlorer output unit	Non-supervised output module
59000-820	XPlorer switch monitor	Supervised input module

C.7 DIN RAIL Modules

Model	Name	Description
55000-803	XP95 DIN RAIL input/output unit	DIN RAIL mount module with 1 input + 1 output
55000-804	XP95 DIN Rail output unit	DIN RAIL mount module with 1 input
55000-821	XP95 DIN RAIL switch monitor plus	DIN RAIL mount module with 1 delayed input and reset output for waterflow detectors (waterflow alarm)
55000-822	XP95 DIN RAIL switch monitor	DIN RAIL mount module with 1 Input
55000-812	XP95 DIN RAIL zone monitor (with isolator)	DIN RAIL mount interface module for conventional detectors (with isolator)
55000-826	XP95 DIN RAIL sounder control unit	DIN RAIL mount module with 1 output for control of externally-powered sounder
55000-802	XP95 DIN RAIL dual isolator	DIN RAIL mount dual isolator

C.8 Modules with isolators

Model	Name	Description
55000-841	XP95 Switch monitor plus with isolator	DIN RAIL mount module with 1 delayed input and reset output for waterflow detectors (waterflow alarm) equipped with isolator
55000-843	XP95 Switch monitor with isolator	Single input module equipped with isolator
55000-845	XP95 Zone monitor with isolator	Interface module for conventional detectors equipped with isolators
55000-847	XP95 Input/Output module with Isolator	Module with 1 relay output + 1 supervised input + 1 non-supervised input (opto-isolated)
55000-849	XP95 Output unit with isolator	Module with 2 relay outputs equipped with isolator
55000-852	XP95 Sounder control unit with isolator	Module with 1 output for control of self-powered audible signalling device equipped with isolator

C.9 Configuring APOLLO devices

Every Apollo device requires an address to identify it on the loop. Apollo devices must be addressed manually, as follows.

C.9.1 Addressing Apollo detectors

You can address Apollo detectors using the incorporated Xpert cards.

Work carefully through the following steps:

1. Remove the detector from its base (twist off).
2. Using a flat-bladed screwdriver or similar tool, push the locking tab and slide the Xpert card out of its holder.
3. Using a flat-bladed screwdriver or similar tool, remove the pips in such way as to assign an address to the Xpert card (refer to the Address Table in the device instructions).

Note: *126 addresses are available.*

4. Using a felt-tip pen or printing device, write/print the respective address on the break-off tags.

Note: *This labeling method will provide visual identification of the system detectors during the system installation phase. When you think you have the system detectors properly wired and addressed, you can either break off the tags or leave them for future reference.*

5. Replace the card.
6. Fit the detector to its base.

C.9.2 Addressing APOLLO modules

You can address all modules in the Apollo range (Input, Output, In/Out, Manual Call point/Sounder/Flasher/Emergency Light, etc.) using the incorporated DIP switches (see following figure).

1. Using the On/Off position of the incorporated DIP switch (refer to the Address Table in the device instructions), set the module address (from 1 to 126).
2. Attach the module to the motherboard.

Order codes

Following are the order codes of INIM Electronics s.r.l. products:

Code	Description
DCMIINE0SLOOP	Installation manual
DCMPINE0SLOOP	Programming manual
DCMUINE0SLOOP	User's manual
IPS24160G	160W, 27.6V switching power-supply battery charger
Link232F9F9	RS232 link
LinkUSBAB	USB cable for PC to INIM device connection
ProbeTH	Thermal probe for battery charge optimization
SmartLAN	Ethernet interface for the Internet connections (TCP-IP and web-server)
SmartLAN/SF	Ethernet interface for the Internet connections (TCP-IP)
SmartLeague	Programming and management software for INIM products (runs on Windows™)
SmartLetUSee/LCD	Repeater: remote control panel with LCD
SmartLetUSee/LED	Remote LED panel
SmartLook	Control software program (runs under Windows™) for INIM systems
SmartLoop/1010-G	1 loop, non-expandable control panel with command panel and display
SmartLoop/1010-P	1 loop, non-expandable control panel, equipped with command panel and display, LED signalling panel and housing for optional SmartLoop/PRN thermal printer
SmartLoop/1010-S	NON-expandable single loop control panel, with unequipped flush front
SmartLoop/2080-G	2 loop control panel, expandable to 8, equipped with command keypad and display
SmartLoop/2080-P	2 loop control panel, expandable to 8, equipped with command keypad and display zone status LED pad and housing for optional SmartLoop/PRN thermal printer
SmartLoop/2080-S	2 loop control panel, expandable to 8, with unequipped flush front
SmartLoop/2L	OpenLoop expansion board
SmartLoop/INOUT	Input/Output expansion board
SmartLoop/NET	HorNet board for SmartLoop control panel network
SmartLoop/PSTN	Voice and digital PSTN dialler board

Notes

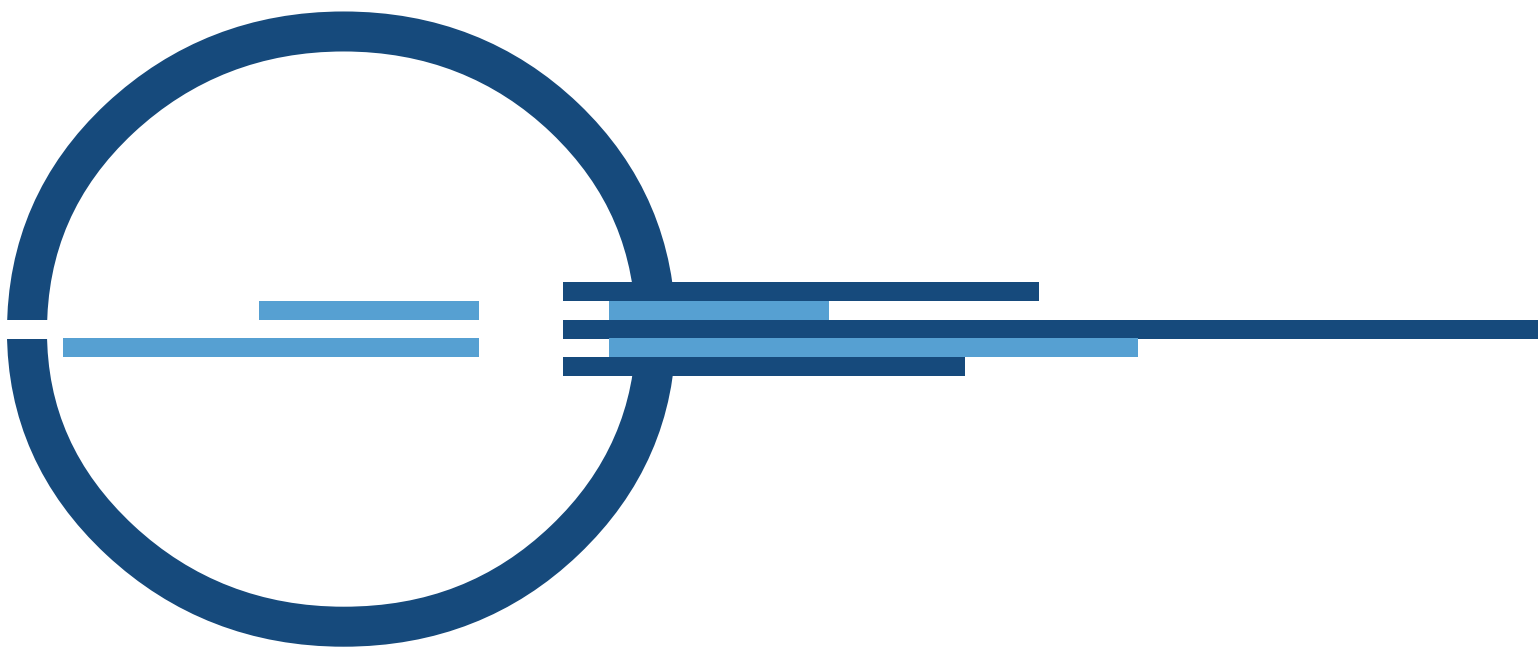

ISO 9001 Quality Management
certified by BSI with certificate number FM530352

via Fosso Antico snc - fraz. Centobuchi
63076 Montepandone (AP) ITALY
Tel. +39 0735 705007 _ Fax +39 0735 704912

info@inim.biz _ www.inim.biz